

7202-08-08-NWO-FG

Steel, SAE J514 37° Flare Male BSPP Adjustable (Type H) Port 90° Elbow, 1/2" Male JIC x 1/2-14 Male BSPP Adjustable ORR

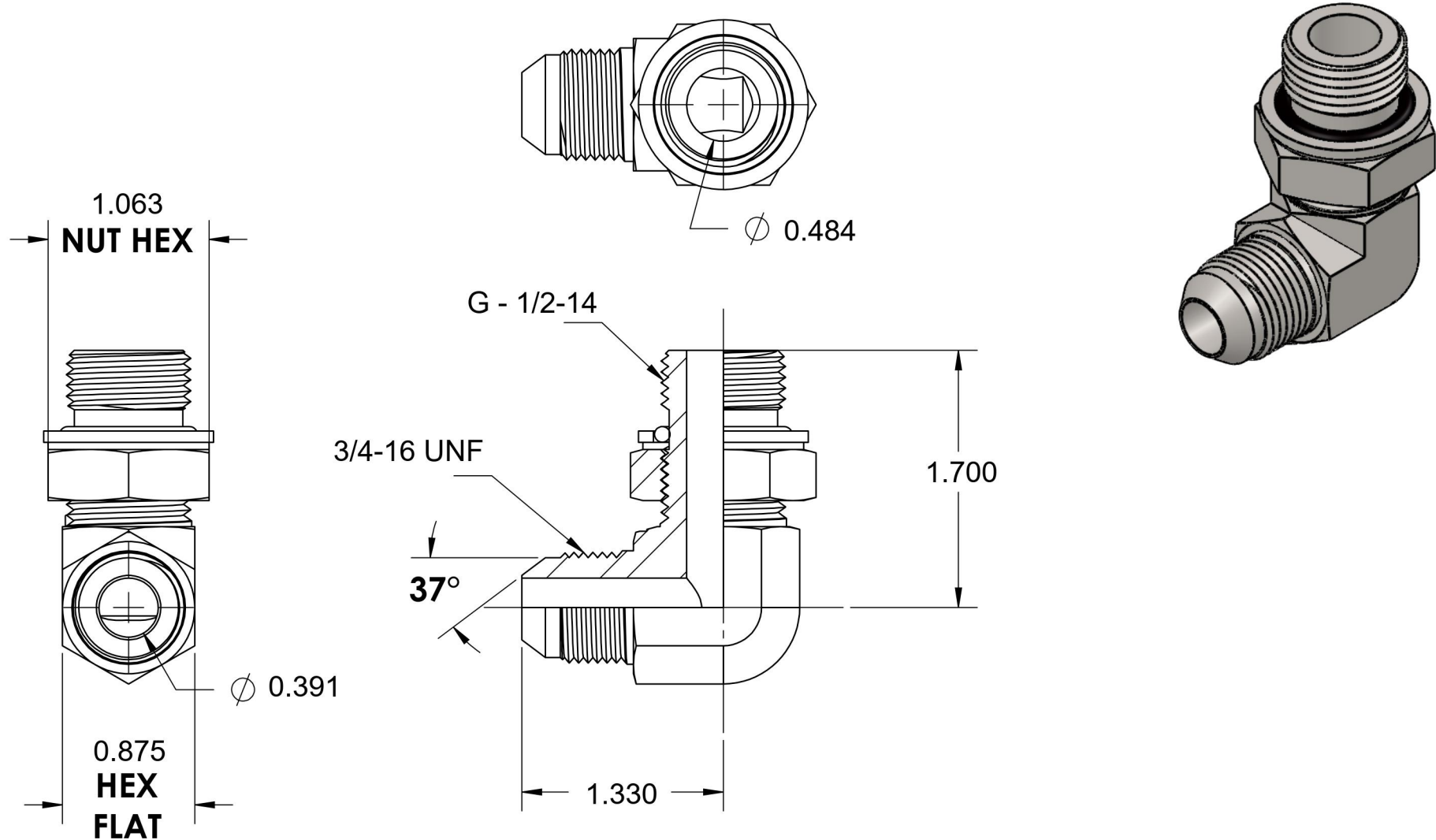

6701 Cochran Road
Solon, Ohio 44139
Phone: (440) 248-1880
Toll Free: 1-888-331-1523

Temperature Rating	Material	Industry Standards	Series
-40°F to 250°F	C1045 Steel	SAE J514, ISO 1179 ASTM B633	7202-NWO-FG-ORR
Pressure Rating	Finish		Series Description
3600 psi	Trivalent Zinc		SAE J514 37° Flare Male BSPP Adjustable (Type H) Port 90° Elbow