

7022-06-06-SS

Stainless Steel, SAE J514 37° Flare Swivel Male BSPP Port/Line Connector, 3/8" Female JIC Swivel x 3/8-19 Male BSPP 60° Line/Port

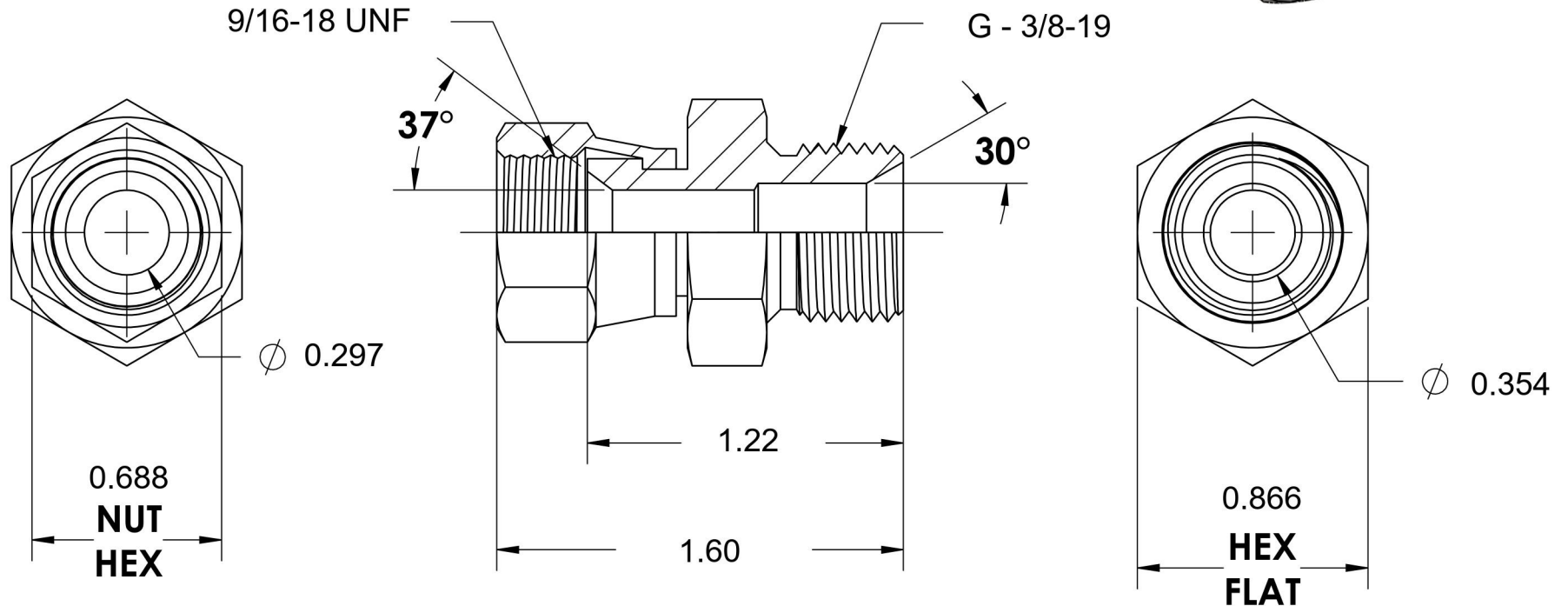

6701 Cochran Road
Solon, Ohio 44139
Phone: (440) 248-1880
Toll Free: 1-888-331-1523

Temperature Rating	Material	Industry Standards	Series
-425°F to 1200°F	316/316L Stainless Steel	SAE J514, ISO 1179	7022-SS
Pressure Rating	Finish	ISO 8434-6	Series Description
5100 psi	Passivated		SAE J514 37° Flare Swivel Male BSPP Port/Line Connector