

# 2700-06-04

## Steel, SAE J514 37° Flare Bulkhead, 3/8" Male JIC x 1/4" Male JIC

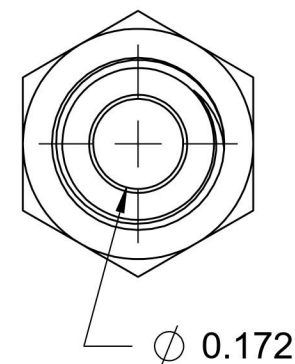
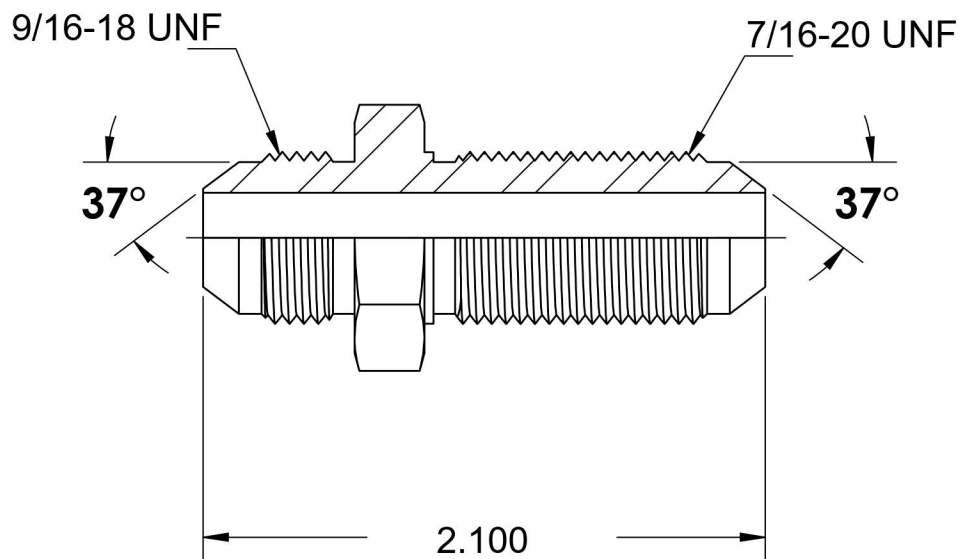
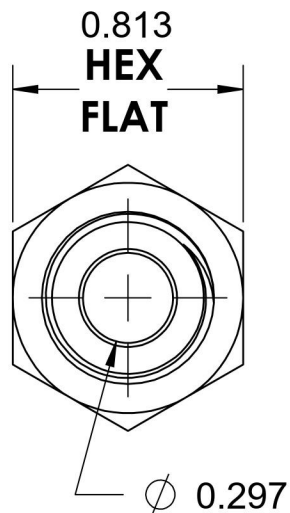
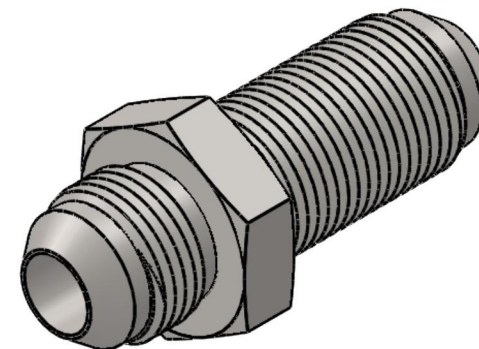

6701 Cochran Road  
Solon, Ohio 44139  
Phone: (440) 248-1880  
Toll Free: 1-888-331-1523

#### Temperature Rating

-65°F to 500°F

#### Pressure Rating

6000 psi

#### Material

C1045/12L14 Steel

#### Finish

Trivalent Zinc

#### Industry Standards

SAE J514, ASTM B633

#### Series

2700

#### Series Description

SAE J514 37° Flare Bulkhead