

FS2501-06-02-FG

Steel, SAE J1453 O-Ring Face Seal 90° Male Elbow, 3/8" Male ORFS x 1/8" Male NPTF 30°

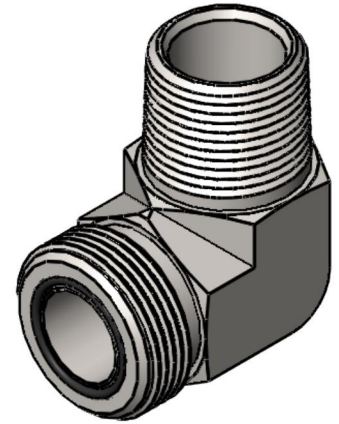
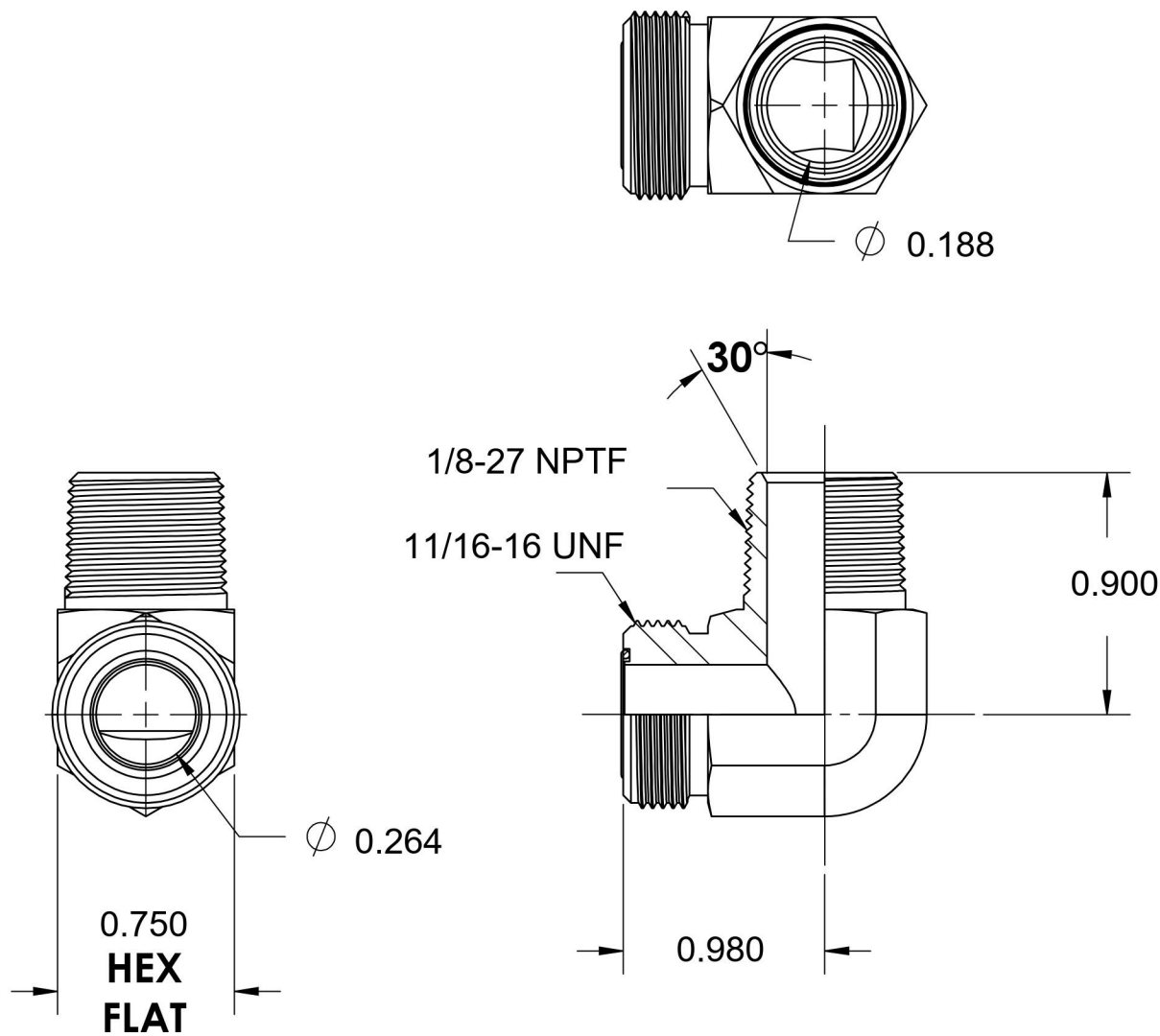

6701 Cochran Road
Solon, Ohio 44139
Phone: (440) 248-1880
Toll Free: 1-888-331-1523

Temperature Rating	Material	Industry Standards	Series
-40°F to 250°F	C1045 Steel	SAE J1453, SAE J476 SAE J515, ASTM B633	FS2501-FG
Pressure Rating	Finish		Series Description
6000 psi	Trivalent Zinc		SAE J1453 O-Ring Face Seal 90° Male Elbow