

2703-LN-08-08-08-SS

Stainless Steel, SAE J514 37° Flare Bulkhead Branch Tee With Lock Nut, 1/2" Male JIC

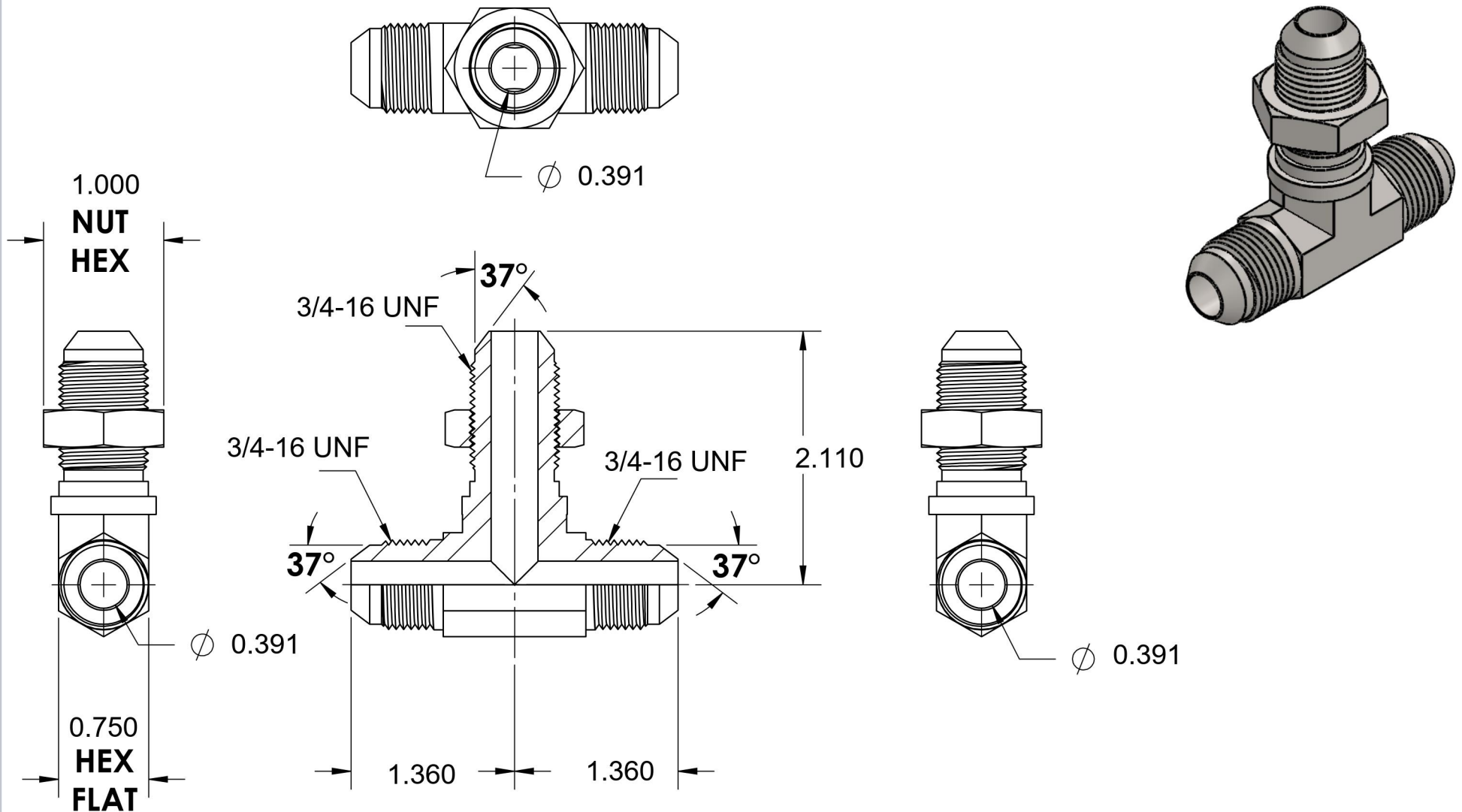

6701 Cochran Road
Solon, Ohio 44139
Phone: (440) 248-1880
Toll Free: 1-888-331-1523

Temperature Rating	-425°F to 1200°F	Material	316/316L Stainless	Industry Standards	SAE J514	Series	2703-LN-FG
Pressure Rating	6000psi	Finish	Passivation			Series Description	SAE J514 37° Flare Bulkhead Branch Tee With Lock Nut