

2501-40-40-SS

Stainless Steel, SAE J514 37° Flare 90° Male Elbow, 2-1/2" Male JIC x 2-1/2" Male NPTF 30°

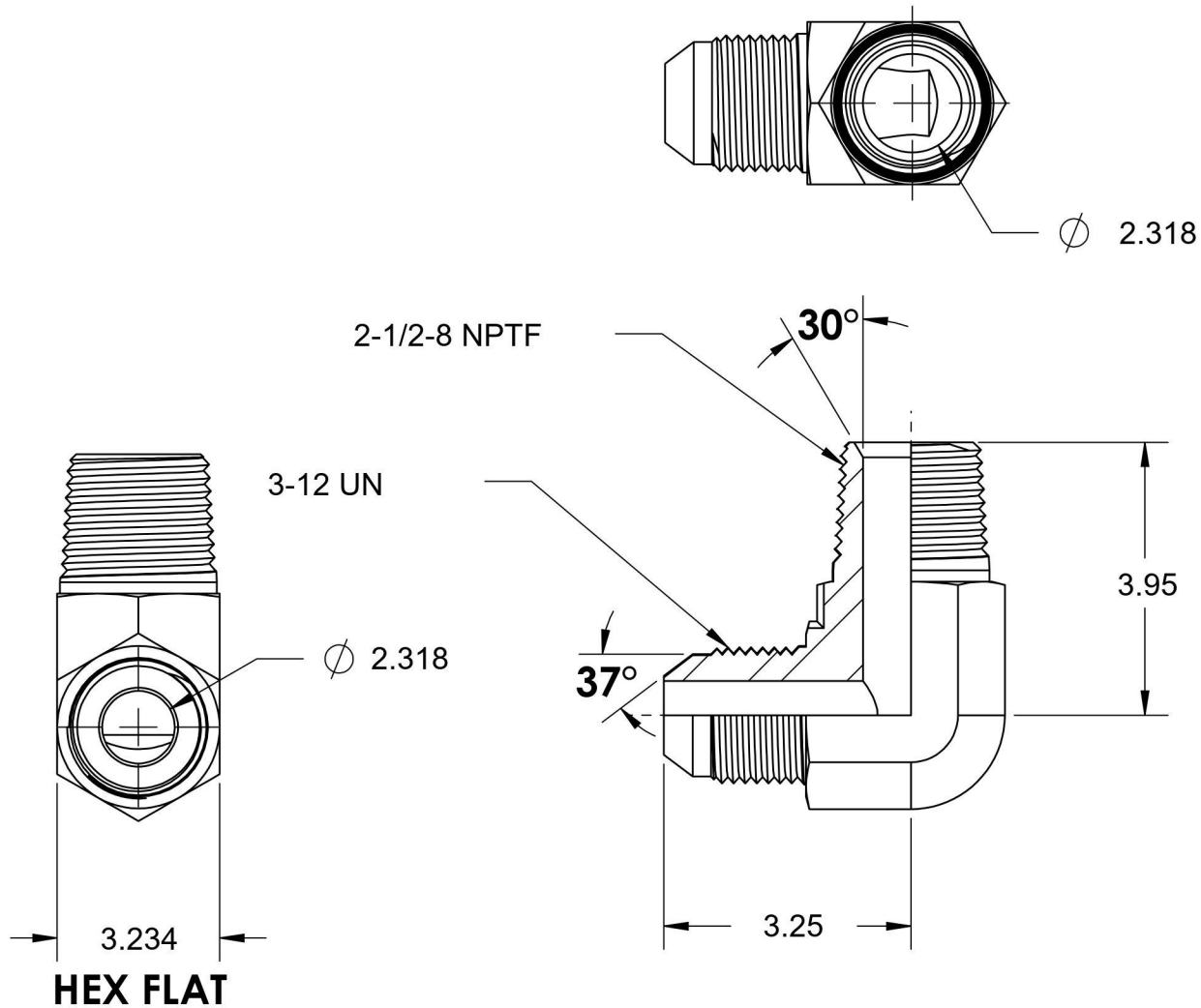

6701 Cochran Road
Solon, Ohio 44139
Phone: (440) 248-1880
Toll Free: 1-888-331-1523

Temperature Rating

-425°F to 1200°F

Pressure Rating

1000 psi

Material

316/316L Stainless Steel

Finish

Passivated

Industry Standards

SAE J514 , SAE J476

Series

2501-SS

Series Description

SAE J514 37° Flare 90° Male Elbow