

2406-06-06-R.050

06FJ-06MJ Straight, Restricted .050"ID

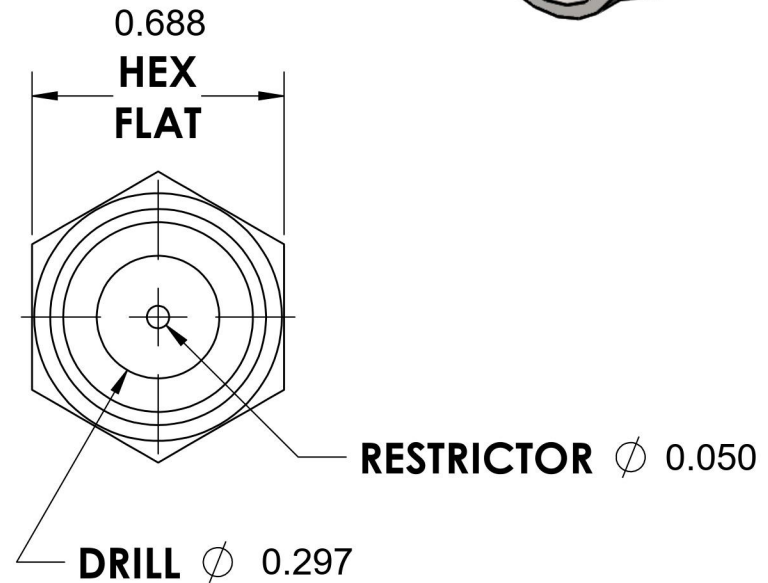
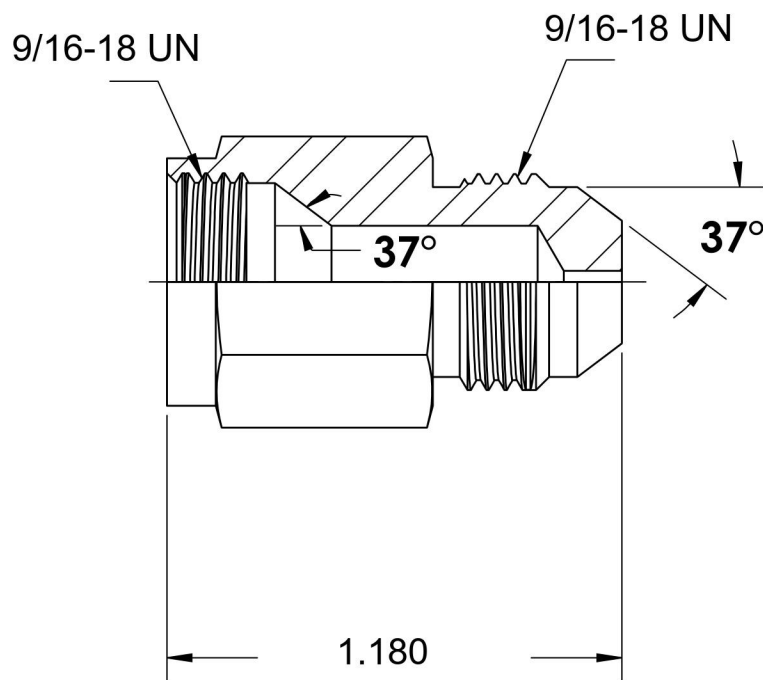
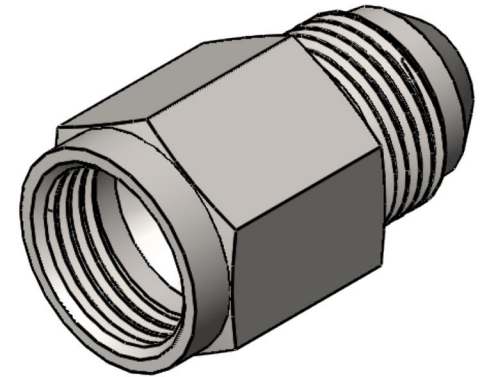

6701 Cochran Road
Solon, Ohio 44139
Phone: (440) 248-1880
Toll Free: 1-888-331-1523

Temperature Rating

-65°F to 500°F

Material

C1045/12L14 Steel

Industry Standards

SAE J514, ASTM B633

Series

2406-RESTRICTED

Pressure Rating

Not Available

Finish

Trivalent Zinc

Series Description

SAE J514 37° Flare Restricted Reducer