

7001-12-30

Steel, SAE J514 37° Flare Male Metric Type (G) Port Adapter, 3/4" Male JIC x M30X2.0 Male Metric ORR

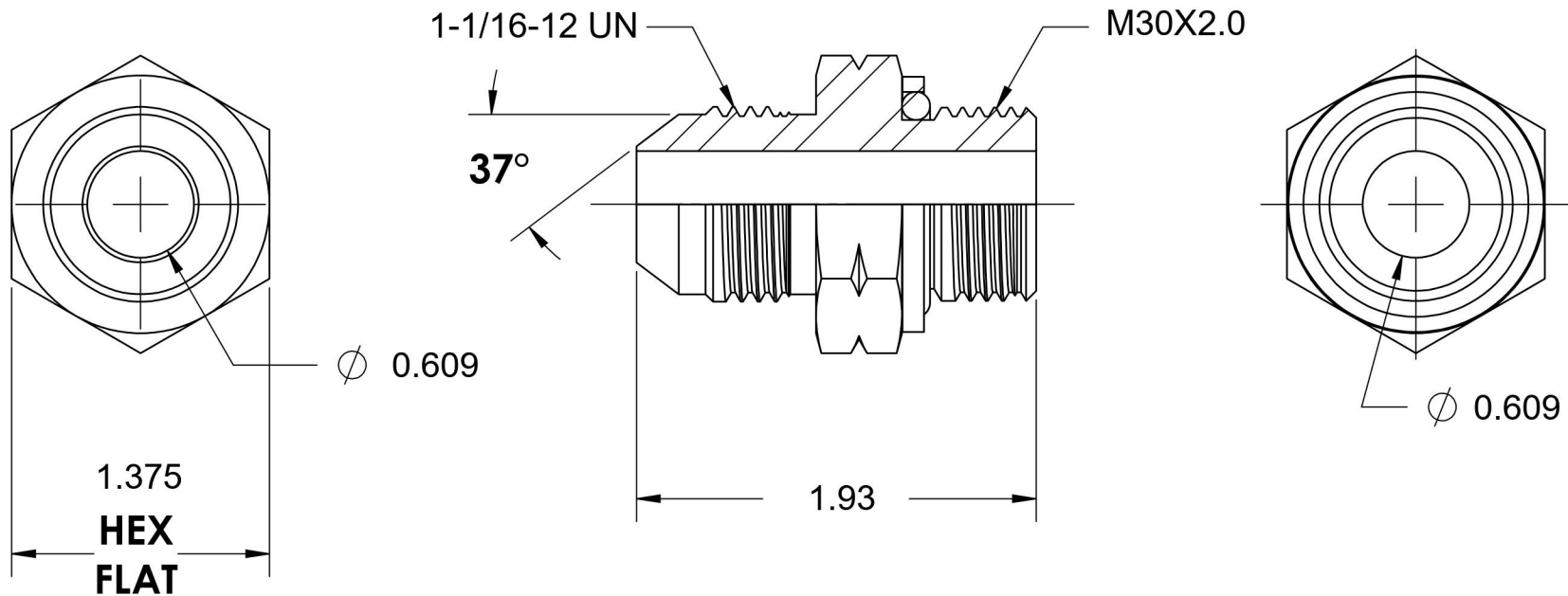

6701 Cochran Road
Solon, Ohio 44139
Phone: (440) 248-1880
Toll Free: 1-888-331-1523

Temperature Rating -22°F to 257°F	Material C1045/12L14 Steel	Industry Standards SAE J514, ISO 9974 ASTM B633	Series 7001-ORR
Pressure Rating 3000 psi	Finish Trivalent Zinc		Series Description SAE J514 37° Flare Male Metric Type (G) Port Adapter