

# D0304-C-L12

Steel, DIN 2353 Blanking Plug, Light 12mm Tube OD

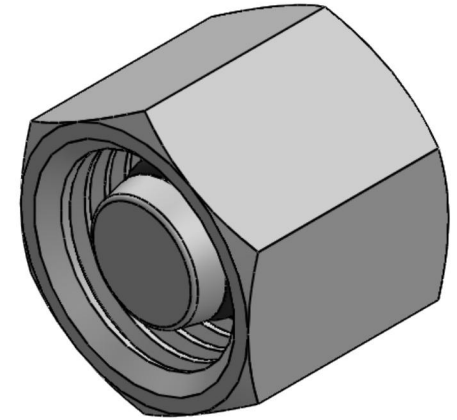
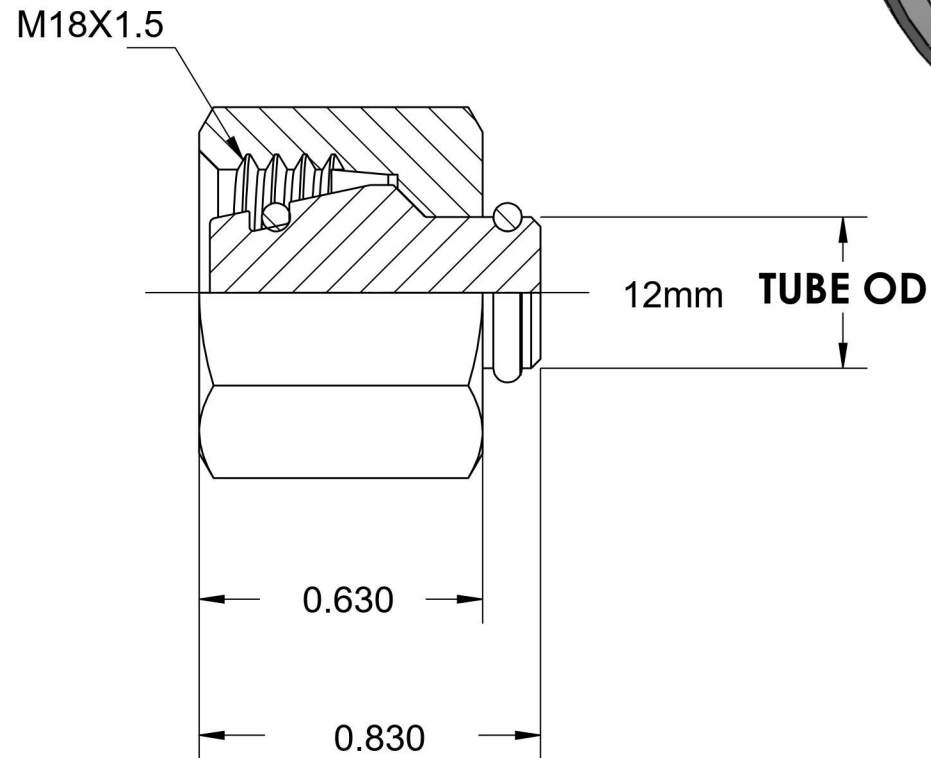
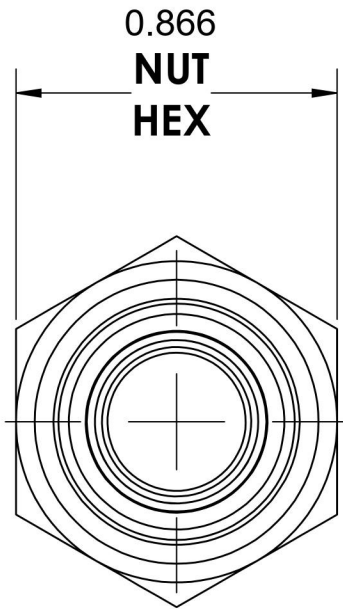

6701 Cochran Road  
Solon, Ohio 44139  
Phone: (440) 248-1880  
Toll Free: 1-888-331-1523

#### Temperature Rating

-40°F to 250°F

#### Pressure Rating

Not Available

#### Material

C22 Steel

#### Finish

Zinc Nickel

#### Industry Standards

DIN 2353, ISO 8434-1

#### Series

D0304-C

#### Series Description

DIN 2353 Flareless Tube  
Blanking Cap Assembly