

6400-L-12-10-O

Steel, SAE J514 37° Flare Long Port Connector, 3/4" Male JIC x 7/8-14 Male ORB

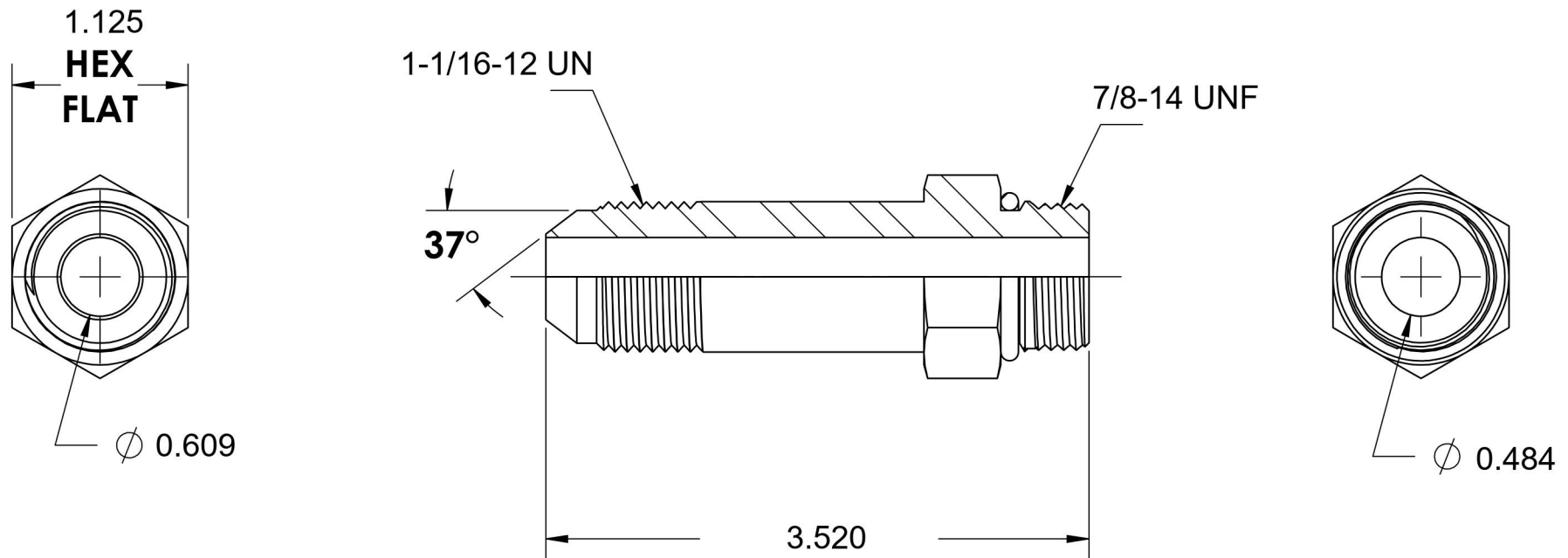
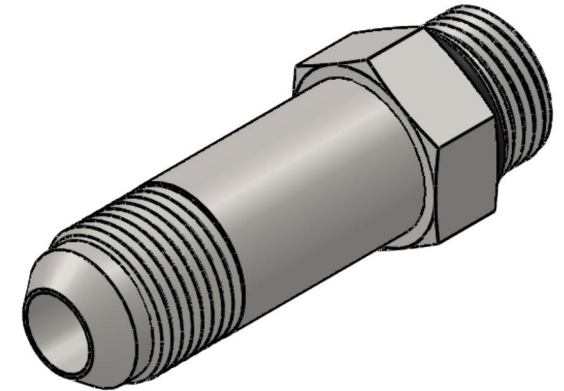

6701 Cochran Road
Solon, Ohio 44139
Phone: (440) 248-1880
Toll Free: 1-888-331-1523

Temperature Rating

-40°F to 250°F

Pressure Rating

5000 psi

Material

C1045/12L14 Steel

Finish

Trivalent Zinc

Industry Standards

SAE J514, SAE J1926-3
SAE J515, ASTM B633

Series

6400-L-O

Series Description

SAE J514 37° Flare
Long Port Connector