

# 6400-04-08-O

Steel, SAE J514 37° Flare Port Connector, 1/4" Male JIC x 3/4-16 Male ORB

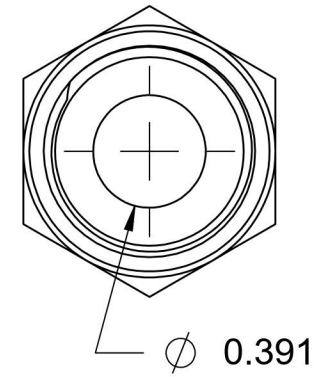
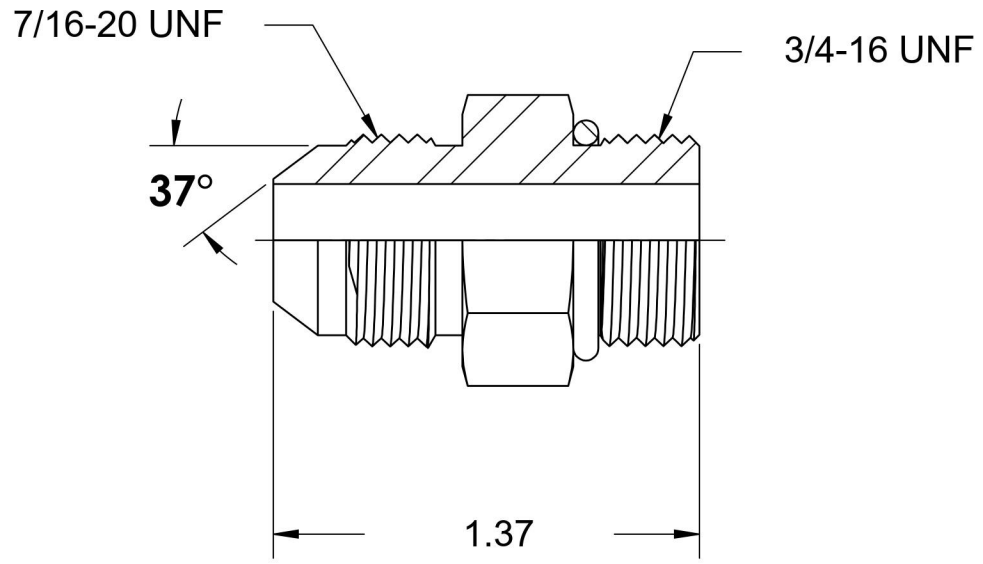
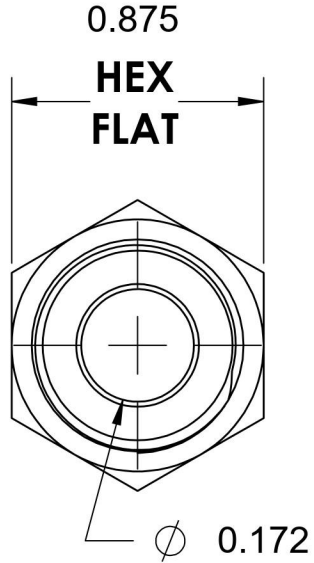

6701 Cochran Road  
Solon, Ohio 44139  
Phone: (440) 248-1880  
Toll Free: 1-888-331-1523

<b>Temperature Rating</b> -40°F to 250°F	<b>Material</b> C1045 / 12L14 Steel	<b>Industry Standards</b> SAE J514, SAE J1926-3 ASTM B633	<b>Series</b> 6400-O
<b>Pressure Rating</b> 6000 psi	<b>Finish</b> Trivalent Zinc		<b>Series Description</b> SAE J514 37° Flare Port Connector