

D2408-S30-SS-X

Stainless Steel, DIN 2353 Plug, Heavy 30mm Tube OD, Body Only

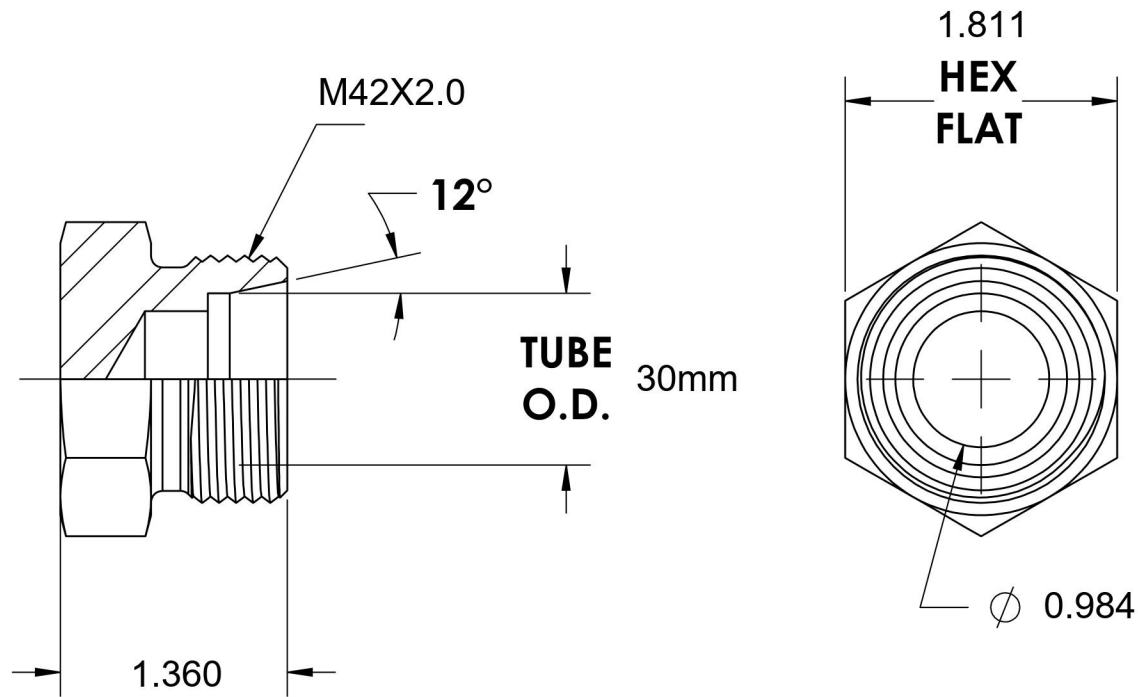
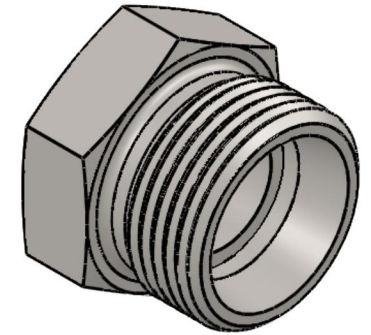

6701 Cochran Road
Solon, Ohio 44139
Phone: (440) 248-1880
Toll Free: 1-888-331-1523

Temperature Rating -425°F to 1200°F	Material 316Ti Stainless Steel	Industry Standards DIN 2353, ISO 8434-1	Series D2408-SS-X
Pressure Rating 6092 psi	Finish Passivated		Series Description DIN 2353 Flareless Tube Plug, Body Only