

7023-06-08

Steel, SAE J514 37° Flare Swivel BSPP Connector, 3/8" Female JIC Swivel x 1/2-14 Female BSPP Swivel

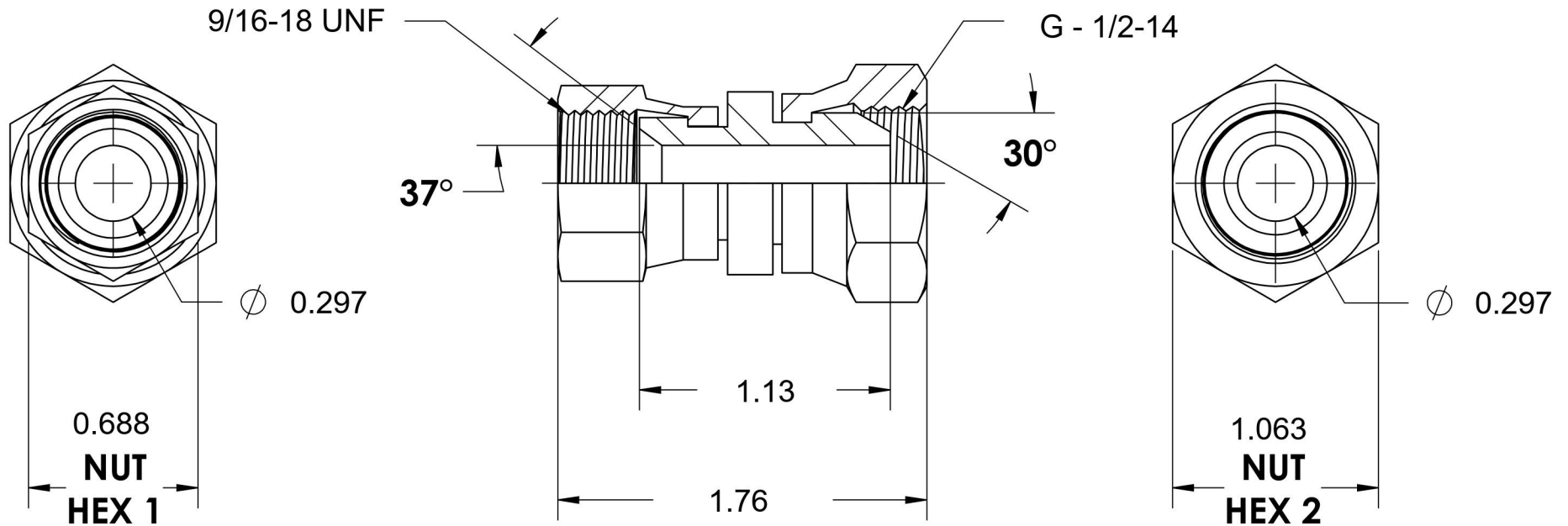
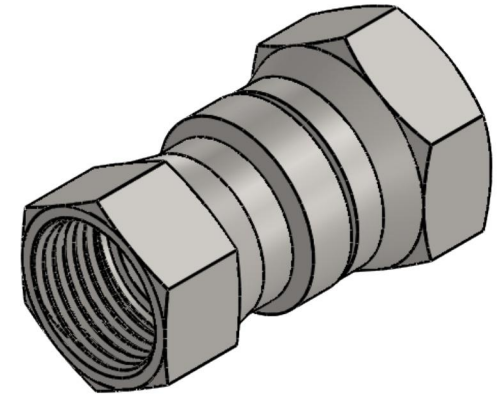

6701 Cochran Road
Solon, Ohio 44139
Phone: (440) 248-1880
Toll Free: 1-888-331-1523

Temperature Rating

-65°F to 500°F

Material

C1045 / 12L14 Steel

Industry Standards

SAE J514, ISO 8434-6

ASTM B633

Series

7023

Pressure Rating

2900 psi

Finish

Trivalent Zinc

Series Description

SAE J514 37° Flare
Swivel BSPP Connector