

7023-10-10

Steel, SAE J514 37° Flare Swivel BSPP Connector, 5/8" Female JIC Swivel x 5/8-14 Female BSPP Swivel

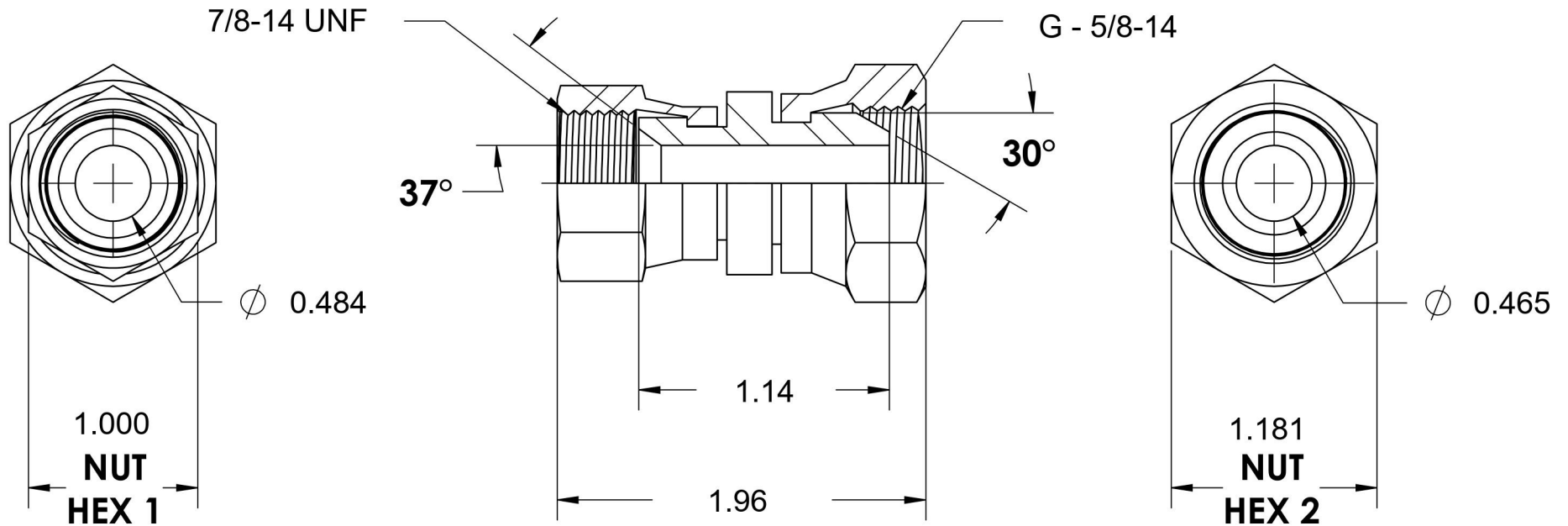
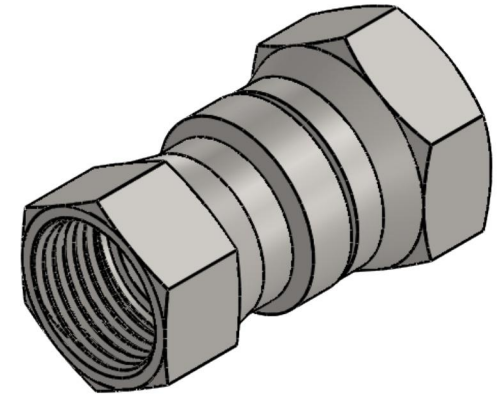

6701 Cochran Road
Solon, Ohio 44139
Phone: (440) 248-1880
Toll Free: 1-888-331-1523

Temperature Rating -65°F to 500°F	Material C1045 / 12L14 Steel	Industry Standards SAE J514, ISO 8434-6 ASTM B633	Series 7023
Pressure Rating 2900 psi	Finish Trivalent Zinc		Series Description SAE J514 37° Flare Swivel BSPP Connector