

2406-08-08-R.213

08FJ-08MJ Straight, Restricted .213"ID

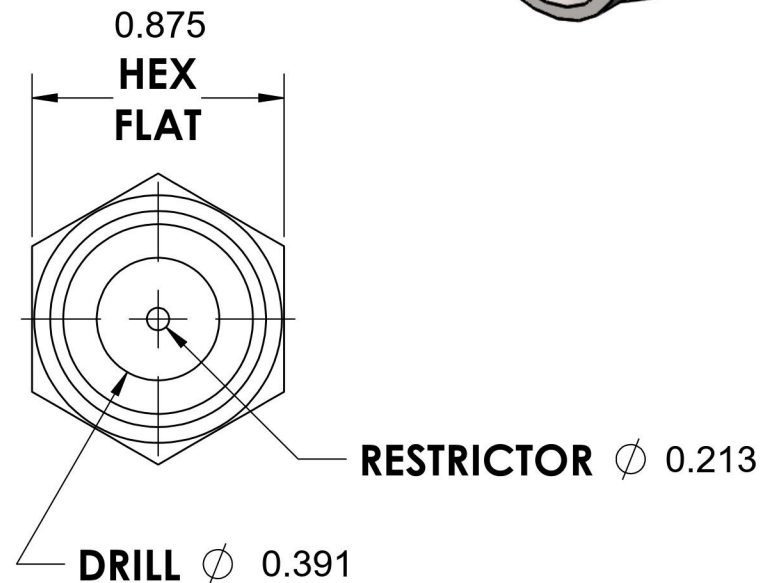
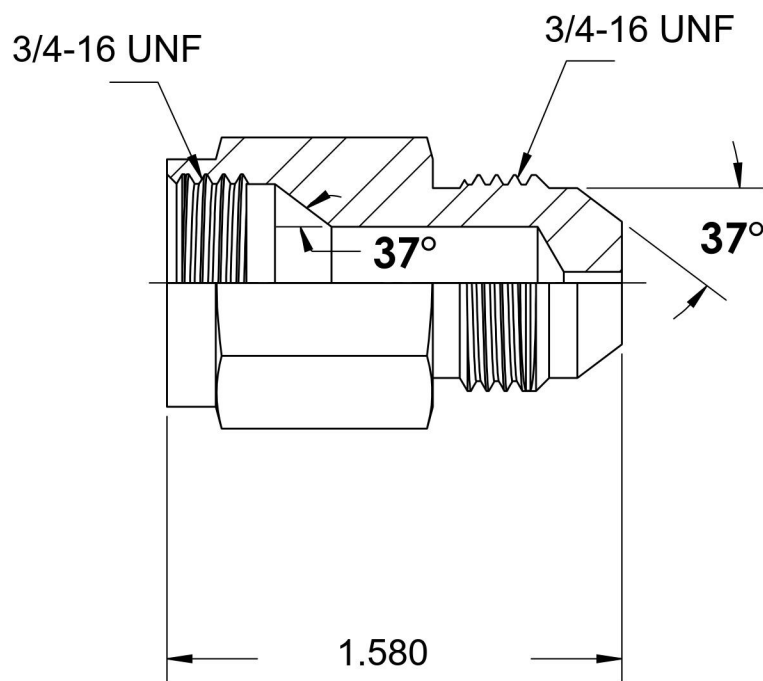
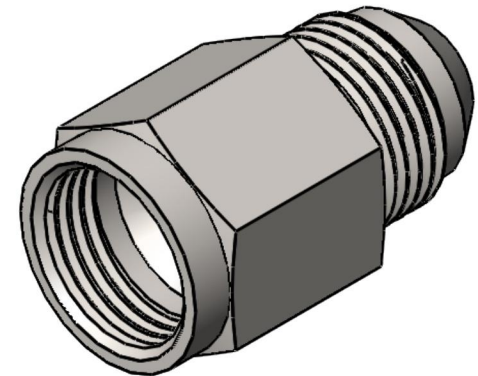

6701 Cochran Road
Solon, Ohio 44139
Phone: (440) 248-1880
Toll Free: 1-888-331-1523

| | | | |
|---|--------------------------------------|--|--|
| Temperature Rating -65°F to 500°F | Material C1045/12L14 Steel | Industry Standards SAE J514, ASTM B633 | Series 2406-RESTRICTED |
| Pressure Rating Not Available | Finish Trivalent Zinc | | Series Description SAE J514 37° Flare Restricted Reducer |