

7005-06-14-BS

Steel, SAE J514 37° Flare Metric Type (D) Bonded Seal Port/Line Connector, 3/8" Male JIC x M14X1.5 Male Metric 60° Line/Port

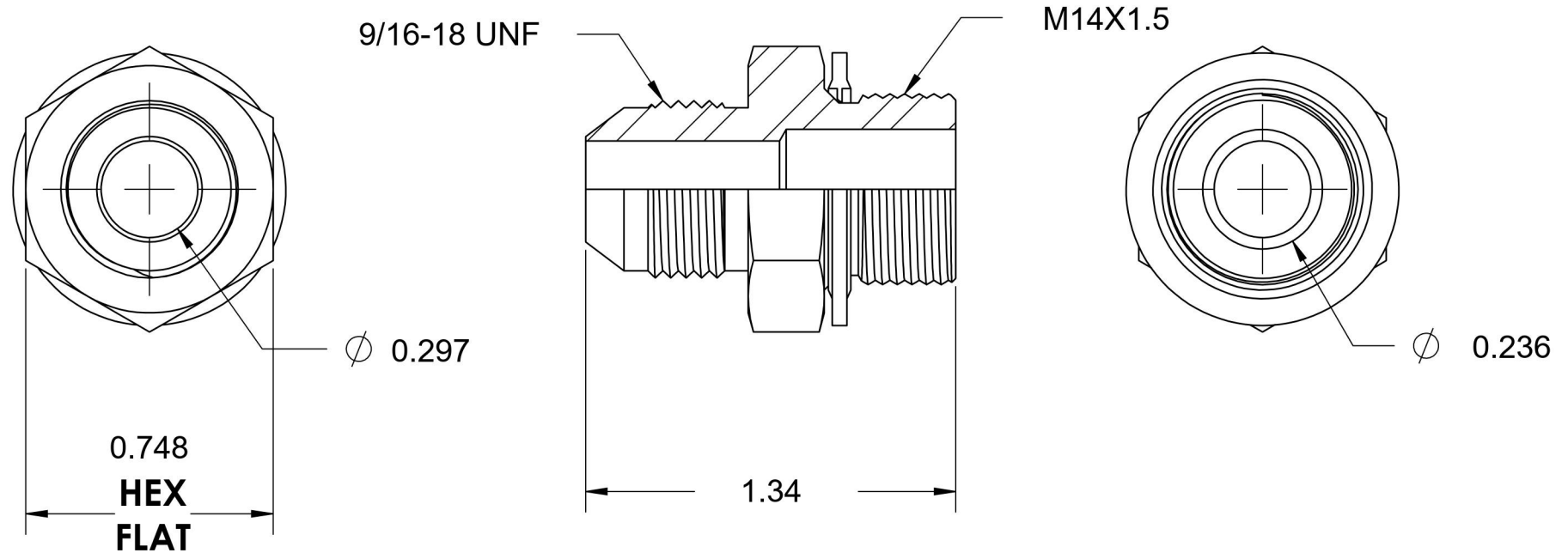

6701 Cochran Road
Solon, Ohio 44139
Phone: (440) 248-1880
Toll Free: 1-888-331-1523

Temperature Rating	Material	Industry Standards	Series
-40°F to 250°F	C1045/12L14 Steel	SAE J514, ISO 9974	7005-BS
Pressure Rating	Finish	ASTM B633	Series Description
6000 psi	Trivalent Zinc		SAE J514 37° Flare Metric Type (D) Bonded Seal Port/Line Connector