

# 6806-12-12-NWO-FG

Steel, SAE J1926 Adjustable O-Ring Boss 90° Male Elbow, 1-1/16-12 Male Adjustable ORB x 3/4" Male NPTF 30°

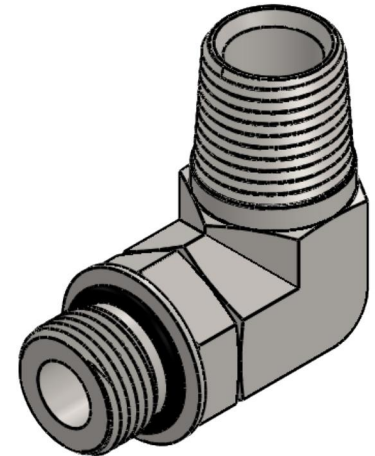
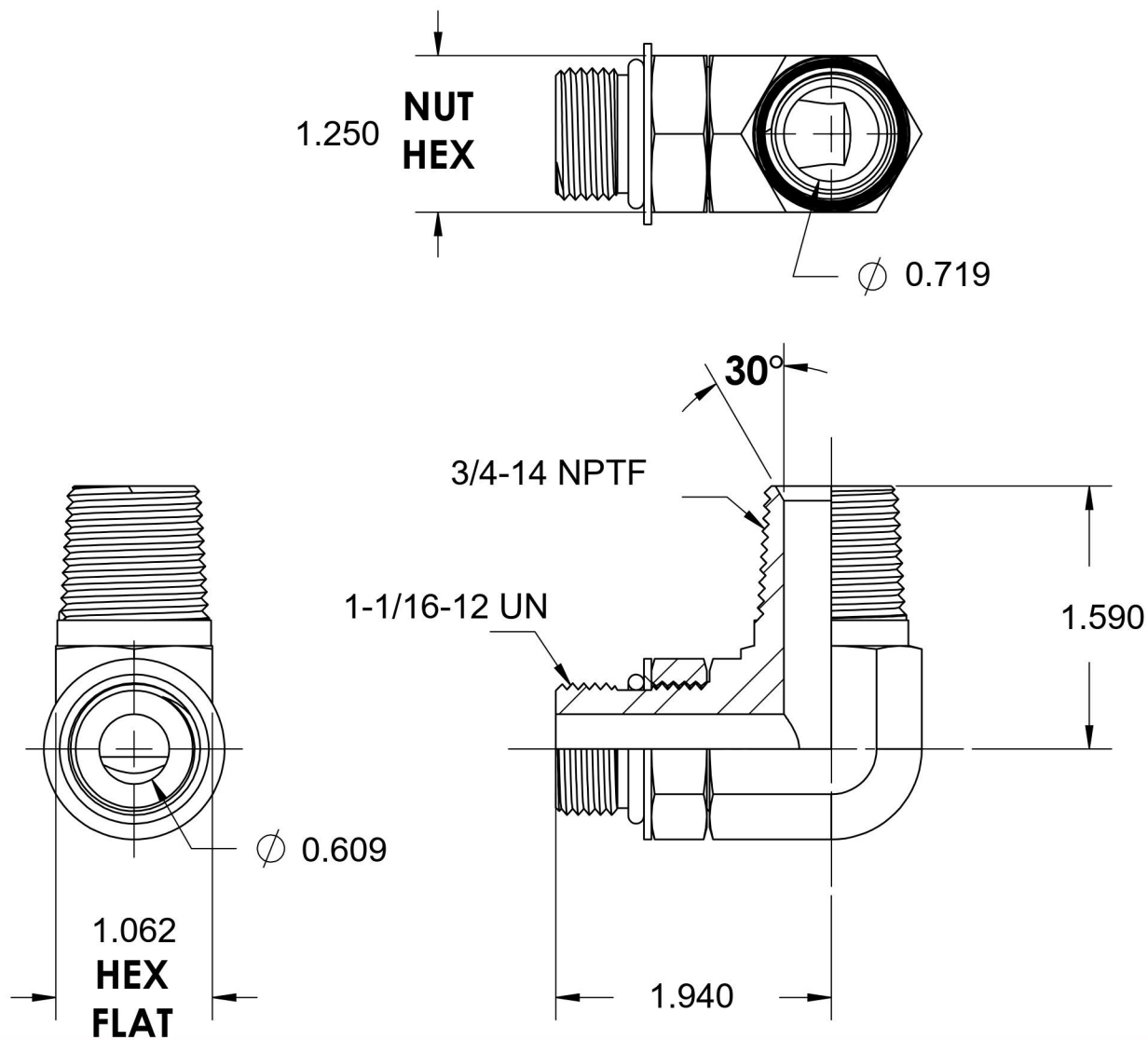

6701 Cochran Road  
Solon, Ohio 44139  
Phone: (440) 248-1880  
Toll Free: 1-888-331-1523

|                           |                 |  |  |
|---------------------------|-----------------|--|--|
| <b>Temperature Rating</b> | <b>Material</b> | <b>Industry Standards</b>                    | <b>Series</b>                                      |
| -40°F to 250°F            | C1045 Steel     | SAE J1926-3, SAE J476<br>SAE J515, ASTM B633 | 6806-NWO-FG  |
| <b>Pressure Rating</b>    | <b>Finish</b>   |  | <b>Series Description</b>                          |
| 3000 psi                  | Trivalent Zinc  |  | SAE J1926 Adjustable O-Ring<br>Boss 90° Male Elbow |