

7022-10-12-SS-BS

Stainless Steel, SAE J514 37° Flare Swivel BSPP Type (D) Bonded Seal Port/Line Connector, 5/8" Female JIC Swivel x 3/4-14 Male BSPP 60° Line/Port

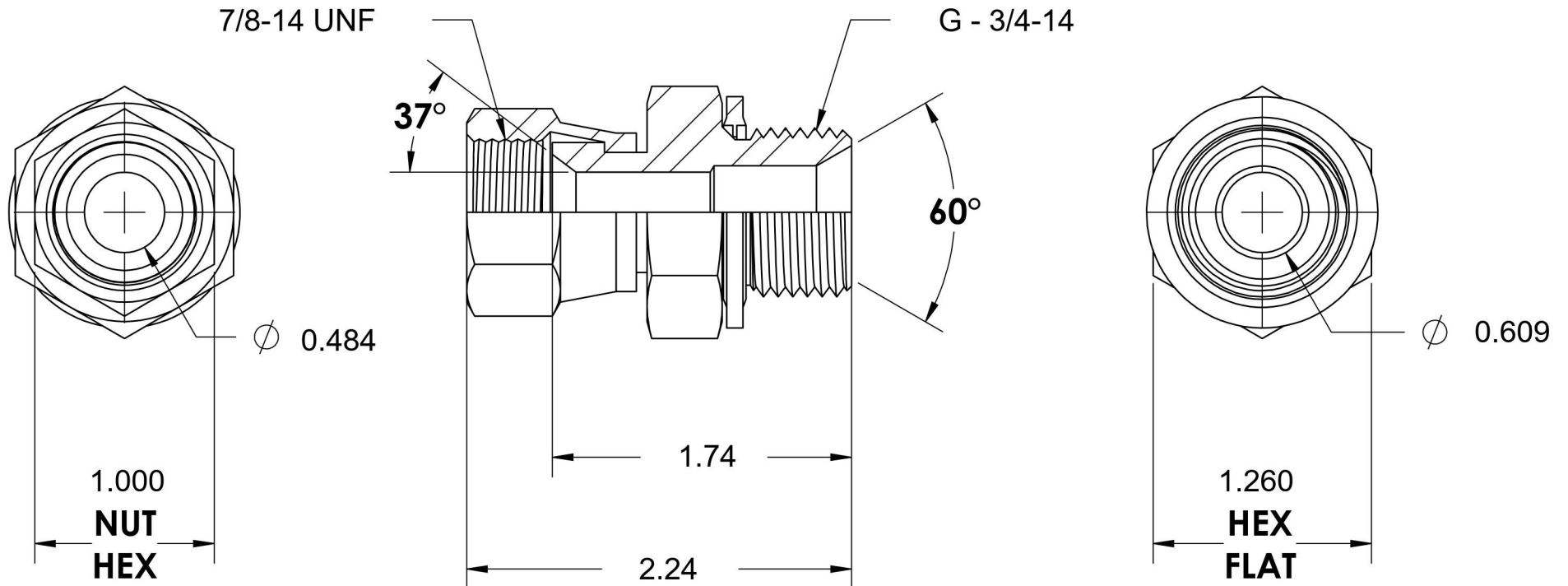
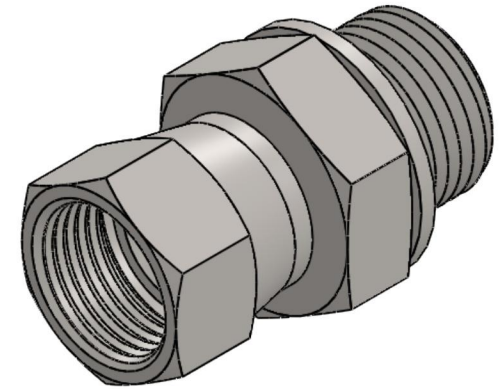

6701 Cochran Road
Solon, Ohio 44139
Phone: (440) 248-1880
Toll Free: 1-888-331-1523

Temperature Rating -40°F to 250°F	Material 316/316L Stainless Steel	Industry Standards SAE J514, ISO 1179 ISO 8434-6	Series 7022-BS-SS
Pressure Rating 2900 psi	Finish Passivated		Series Description SAE J514 37° Flare Swivel BSPP Type (D) Bonded Seal Port/Line Connector