

7005-20-42

Steel, SAE J514 37° Flare Male Metric Port/Line Connector, 1-1/4" Male JIC x M42X2.0 Male Metric 60° Line/Port

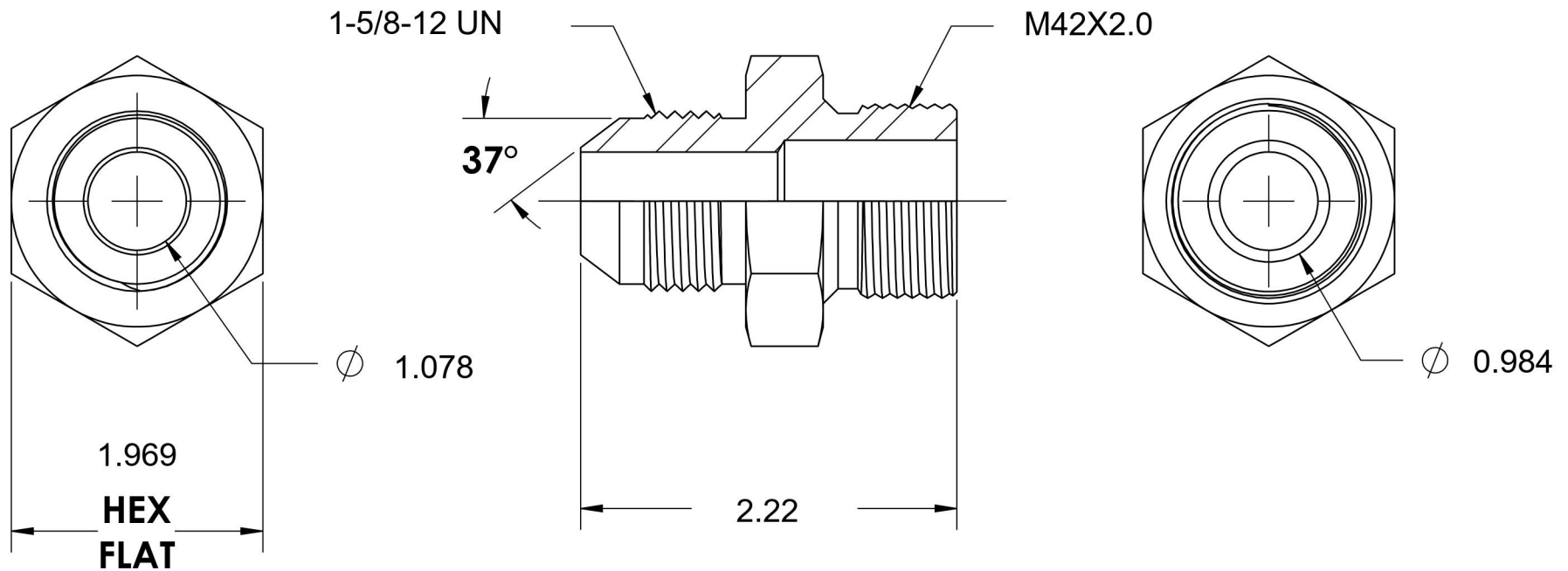

6701 Cochran Road
Solon, Ohio 44139
Phone: (440) 248-1880
Toll Free: 1-888-331-1523

Temperature Rating	Material	Industry Standards	Series
-65°F to 500°F	C1045/12L14 Steel	SAE J514, ISO 9974	7005
Pressure Rating	Finish	ASTM B633	Series Description
2500 psi	Trivalent Zinc		SAE J514 37° Flare Male Metric Port/Line Connector