

# 6809-32-32-NWO-FG

Steel, SAE J514 37° Flare Swivel 90° Adjustable Port Elbow, 2-1/2-12 Male Adjustable ORB x 2" Female JIC Swivel

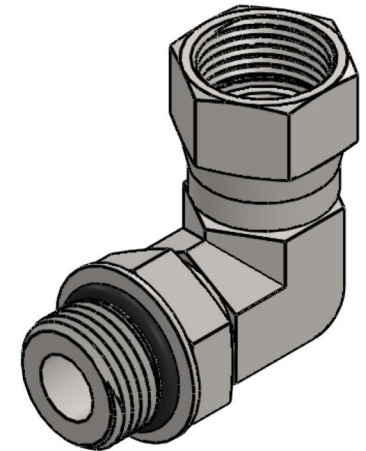
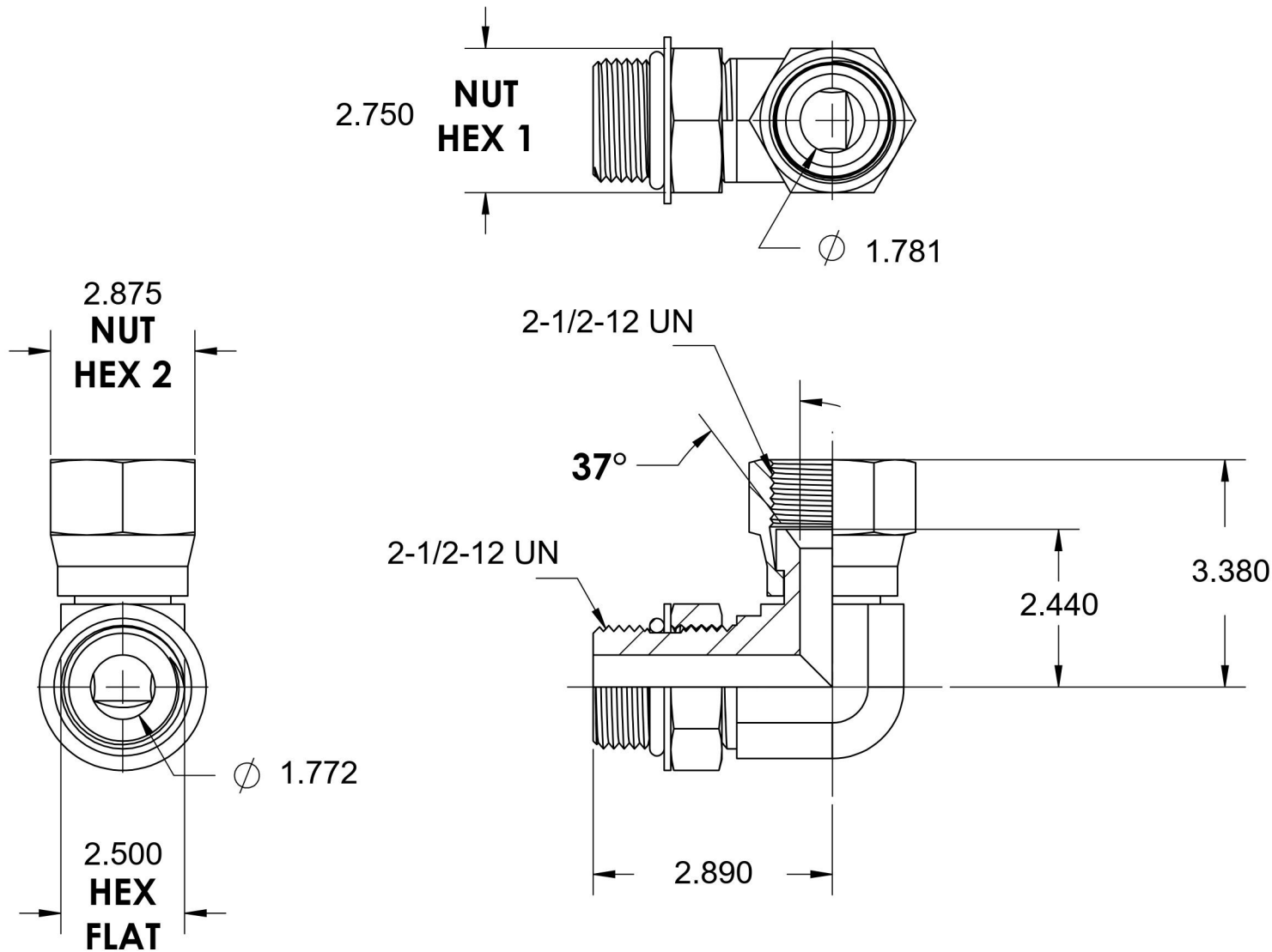

6701 Cochran Road  
Solon, Ohio 44139  
Phone: (440) 248-1880  
Toll Free: 1-888-331-1523

**Temperature Rating**

-40°F to 250°F

**Pressure Rating**

2000 psi

**Material**

C1045 Steel

**Finish**

Trivalent Zinc

**Industry Standards**

SAE J1926, SAE J514  
ASTM B633

**Series**

6809-NWO-FG

**Series Description**

SAE J514 37° Flare Swivel 90°  
Adjustable Port Elbow