

0319-10

Steel, SAE J514 37° Flare Tube Sleeve, 5/8" JIC Tube Sleeve

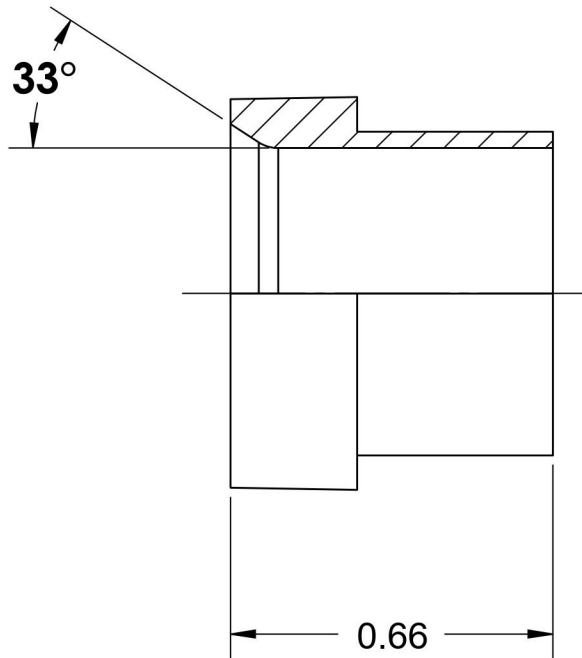
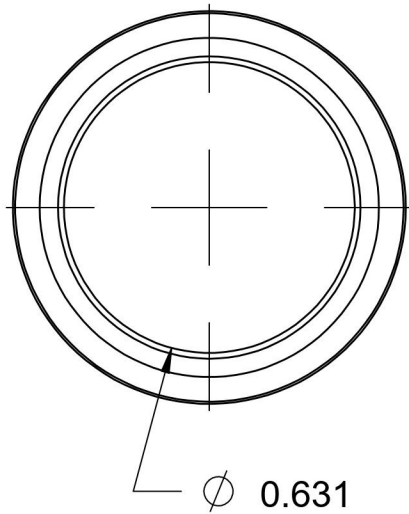

6701 Cochran Road
Solon, Ohio 44139
Phone: (440) 248-1880
Toll Free: 1-888-331-1523

Temperature Rating -65°F to 500°F	Material C1045 / 12L14 Steel	Industry Standards SAE J514, ASTM B633	Series 0319
Pressure Rating Not Applicable	Finish Trivalent Zinc		Series Description SAE J514 37° Flare Tube Sleeve