

7005-08-S25-36-SS

Stainless Steel, SAE J514 37° Flare/ISO 8434-1 Heavy Series Male Adapter, 1/2" Male JIC x M36X2.0 Male DIN

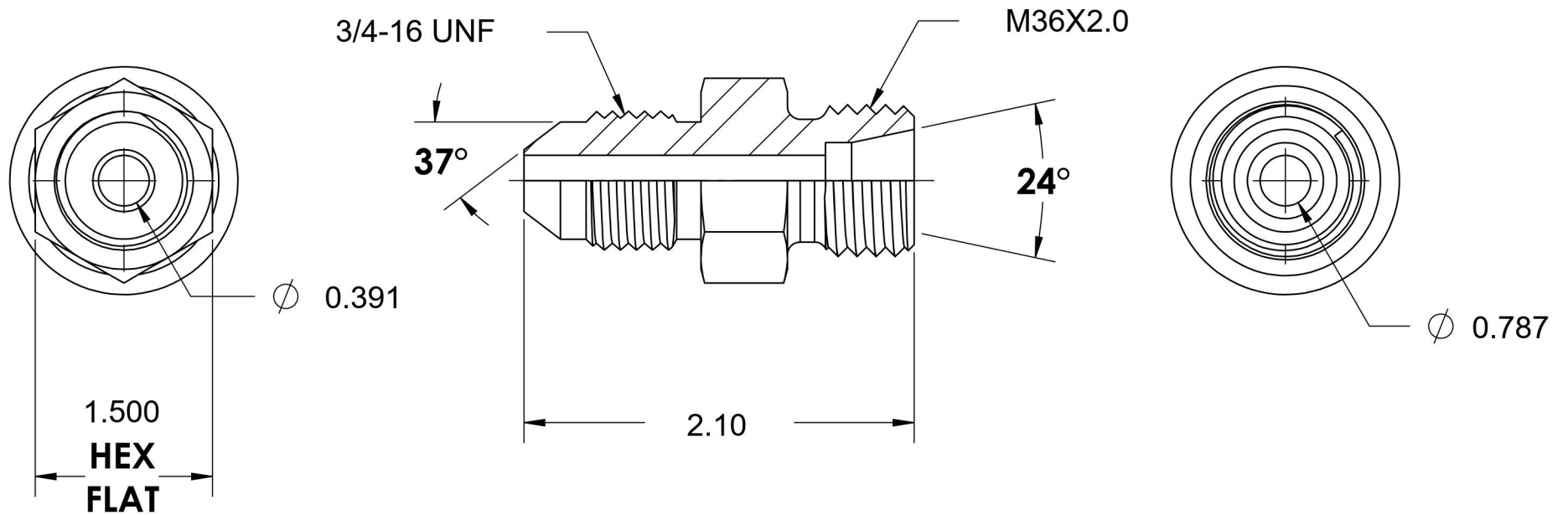

6701 Cochran Road
Solon, Ohio 44139
Phone: (440) 248-1880
Toll Free: 1-888-331-1523

Temperature Rating -425°F to 1200°F	Material 316/316L Stainless Steel	Industry Standards SAE J514, ISO 8434-1 DIN 2353	Series 7005-DIN HEAVY-SS
Pressure Rating 6000 psi	Finish Passivated		Series Description SAE J514 37° Flare/ISO 8434-1 Heavy Series Male Adapter