

FS6400-08-08-O-VITON

Steel, SAE J1453 O-Ring Face Seal Port Connector, 1/2" Male ORFS x 3/4-16 Male ORB, FKM Seal

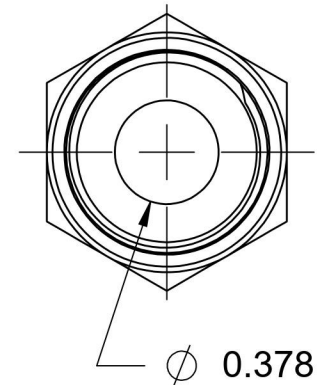
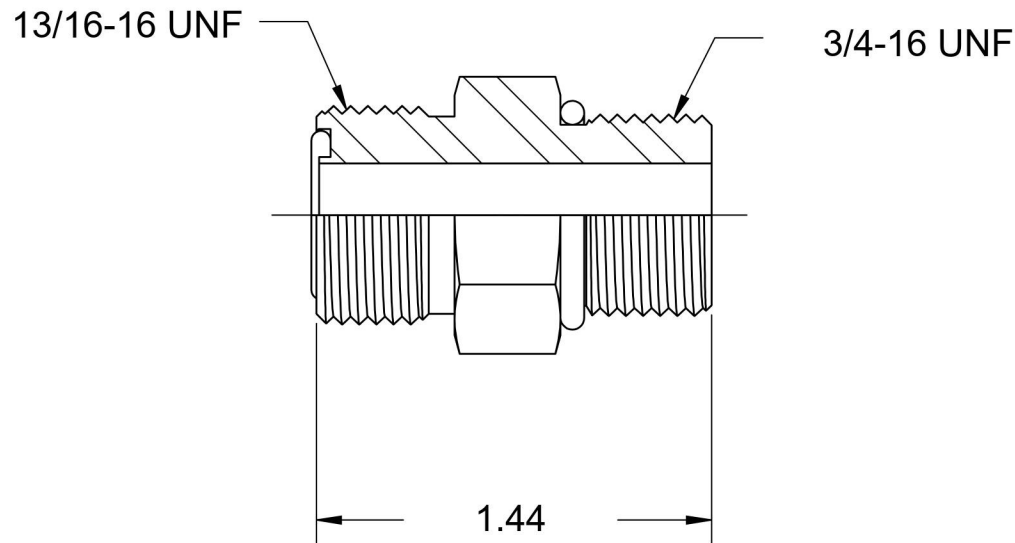
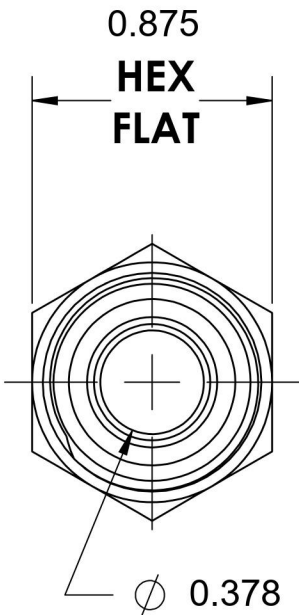

6701 Cochran Road
Solon, Ohio 44139
Phone: (440) 248-1880
Toll Free: 1-888-331-1523

Temperature Rating	Material	Industry Standards SAE J1453, SAE J1926-2 ASTM B633	Series FS6400-O-VITON
-15°F to 400°F	C1045 / 12L14 Steel		
Pressure Rating	Finish	Series Description SAE J1453 O-Ring Face Seal Port Connector	
9200 psi	Trivalent Zinc		