

# 6902-04-02-NWO-FG

Steel, SAE J514 NPSM Swivel 45° Adjustable Port Elbow, 7/16-20 Male Adjustable ORB x 1/8" Female NPSM Swivel

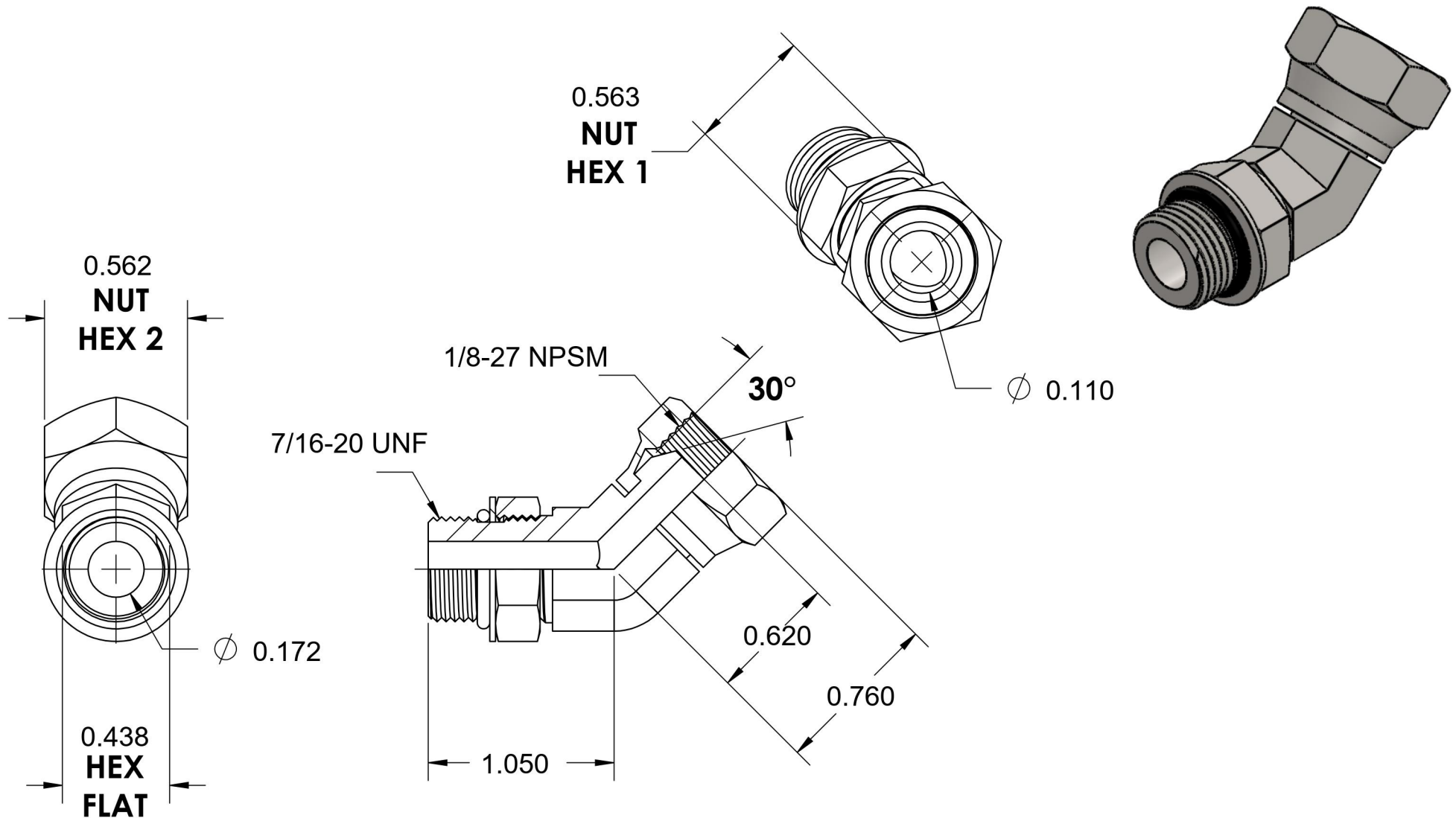

6701 Cochran Road  
Solon, Ohio 44139  
Phone: (440) 248-1880  
Toll Free: 1-888-331-1523

**Temperature Rating**

-40°F to 250°F

**Pressure Rating**

6000psi

**Material**

C1045 Steel

**Finish**

Trivalent Zinc

**Industry Standards**

SAE J514, SAE J1926-3  
SAE J515, ASTM B633

**Series**

6902-NWO-FG

**Series Description**

SAE J514 NPSM Swivel 45° Adjustable Port Elbow