

7030-04-06-SS

Stainless Steel, SAE J476 Pipe Male BSPT Nipple, 1/4" Male NPTF 30° x 3/8" Male BSPT

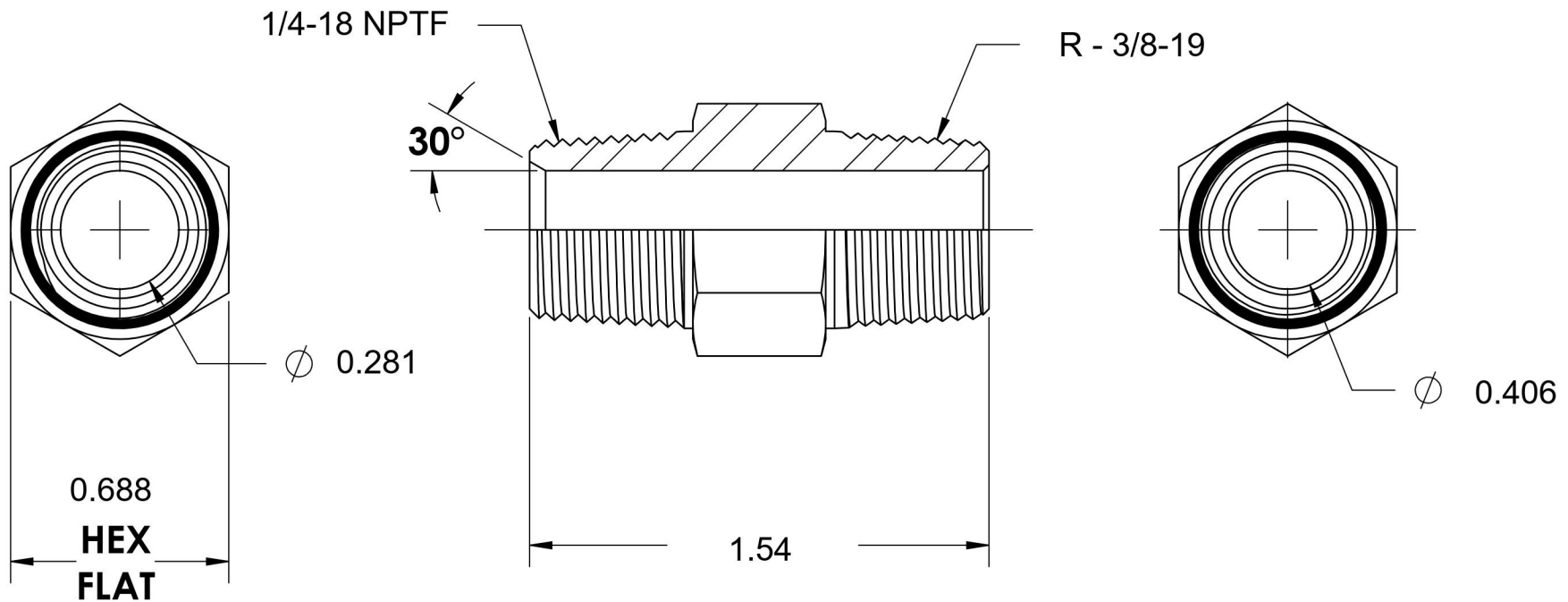

6701 Cochran Road
Solon, Ohio 44139
Phone: (440) 248-1880
Toll Free: 1-888-331-1523

Temperature Rating -425°F to 1200°F	Material 316/316L Stainless Steel	Industry Standards SAE J476, ISO 7-1	Series 7030-SS
Pressure Rating 6000 psi	Finish Passivated		Series Description SAE J476 Pipe Male BSPT Nipple