

# 2403-04-04

Steel, SAE J514 37° Flare Union, 1/4" Male JIC x 1/4" Male JIC

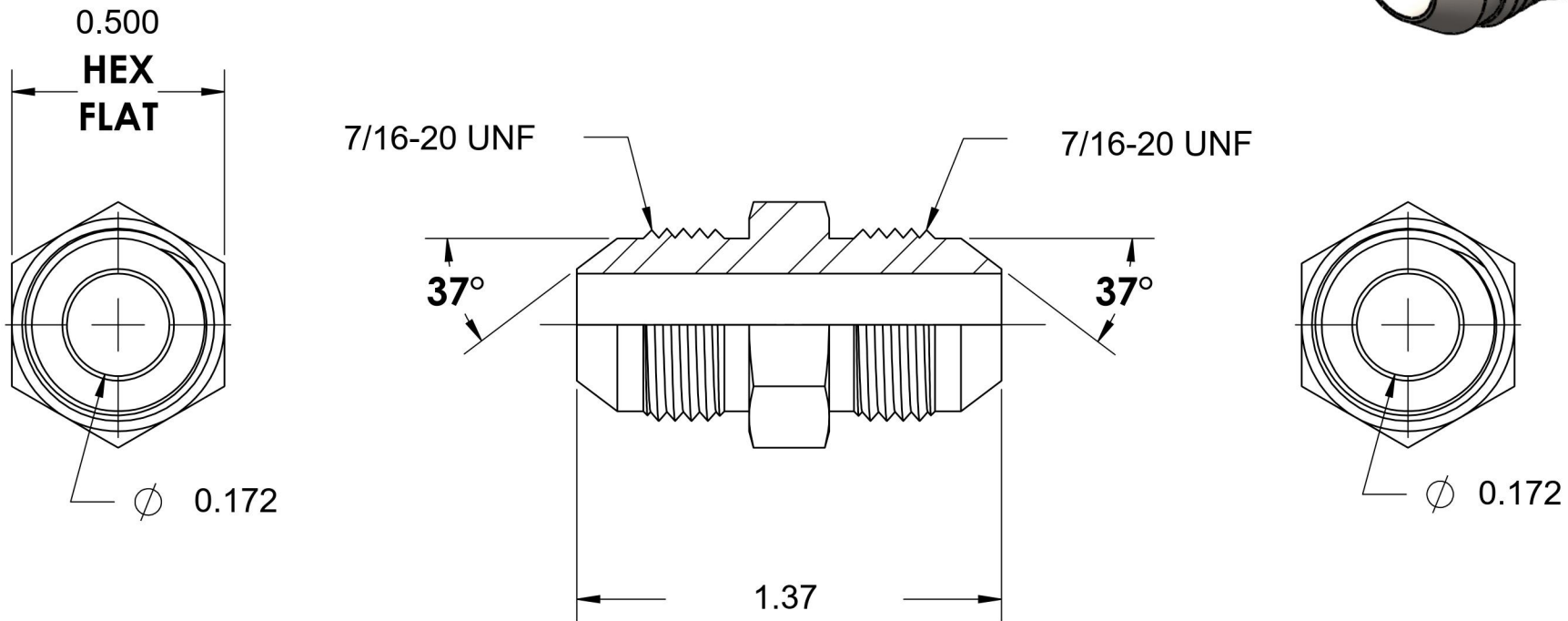

6701 Cochran Road  
Solon, Ohio 44139  
Phone: (440) 248-1880  
Toll Free: 1-888-331-1523

<b>Temperature Rating</b> -65°F to 500°F	<b>Material</b> C1045/12L14 Steel	<b>Industry Standards</b> SAE J514, ASTM B633	<b>Series</b> 2403
<b>Pressure Rating</b> 7500 psi	<b>Finish</b> Trivalent Zinc		<b>Series Description</b> SAE J514 37° Flare Union