

FS7202-08-06-NWO-FG-VITON

Steel, SAE J1453 O-Ring Face Seal Male BSPP Adjustable (Type H) Port 90° Elbow, 1/2" Male ORFS x 3/8-19 Male BSPP Adjustable ORR, FKM Seal

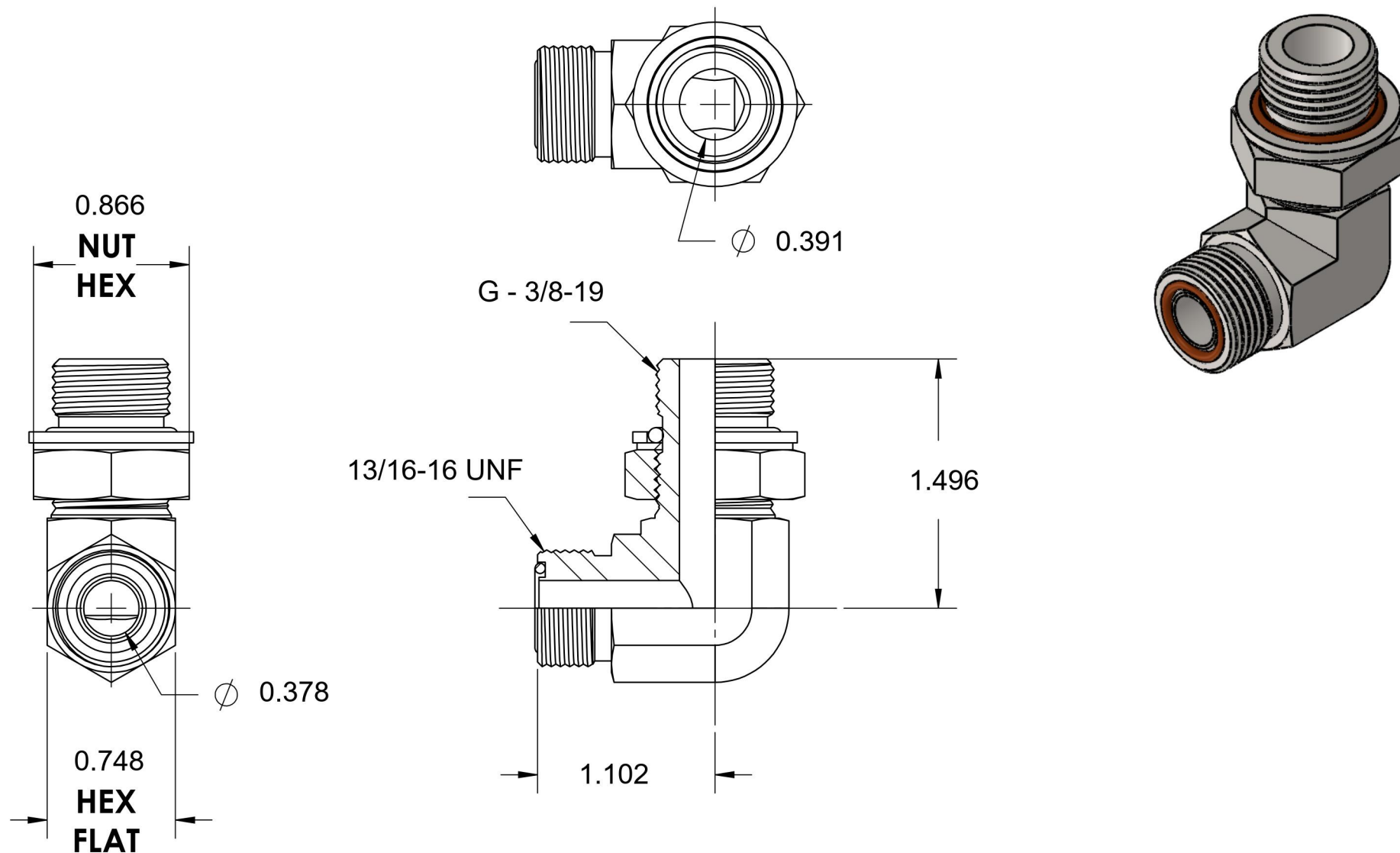

6701 Cochran Road
Solon, Ohio 44139
Phone: (440) 248-1880
Toll Free: 1-888-331-1523

Temperature Rating	Material	Industry Standards	Series
-15°F to 400°F	C1045 Steel	SAE J1453, ISO 1179 ASTM B633	FS7202-NWO-FG-ORR
Pressure Rating	Finish		Series Description
4000psi	Trivalent Zinc		SAE J1453 O-Ring Face Seal Male BSPP Adjustable (Type H) Port 90° Elbow