

# C2403-06-06-SS

Stainless Steel, SAE J514 Flareless Tube Union, 3/8" Flareless Bite Type x 3/8" Flareless Bite Type

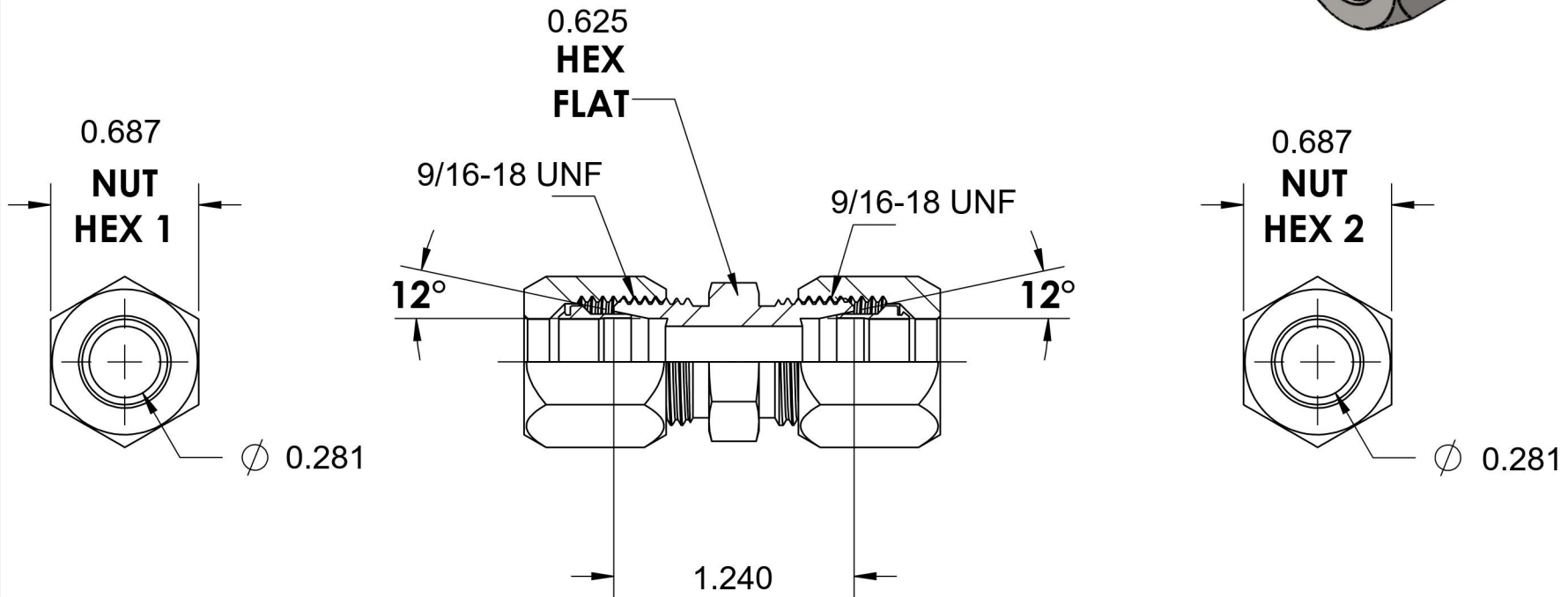

6701 Cochran Road  
Solon, Ohio 44139  
Phone: (440) 248-1880  
Toll Free: 1-888-331-1523

<b>Temperature Rating</b>	<b>Material</b>	<b>Industry Standards</b>	<b>Series</b>
-425°F to 1200°F	316/316L Stainless Steel	SAE J514	C2403-SS
<b>Pressure Rating</b>	<b>Finish</b>		<b>Series Description</b>
6000 psi	Passivated		SAE J514 Flareless Tube Union