

7202-12-12-NWO-FG-VITON

Steel, SAE J514 37° Flare Male BSPP Adjustable (Type H) Port 90° Elbow, 3/4" Male JIC x 3/4-14 Male BSPP Adjustable ORR, FKM Seal

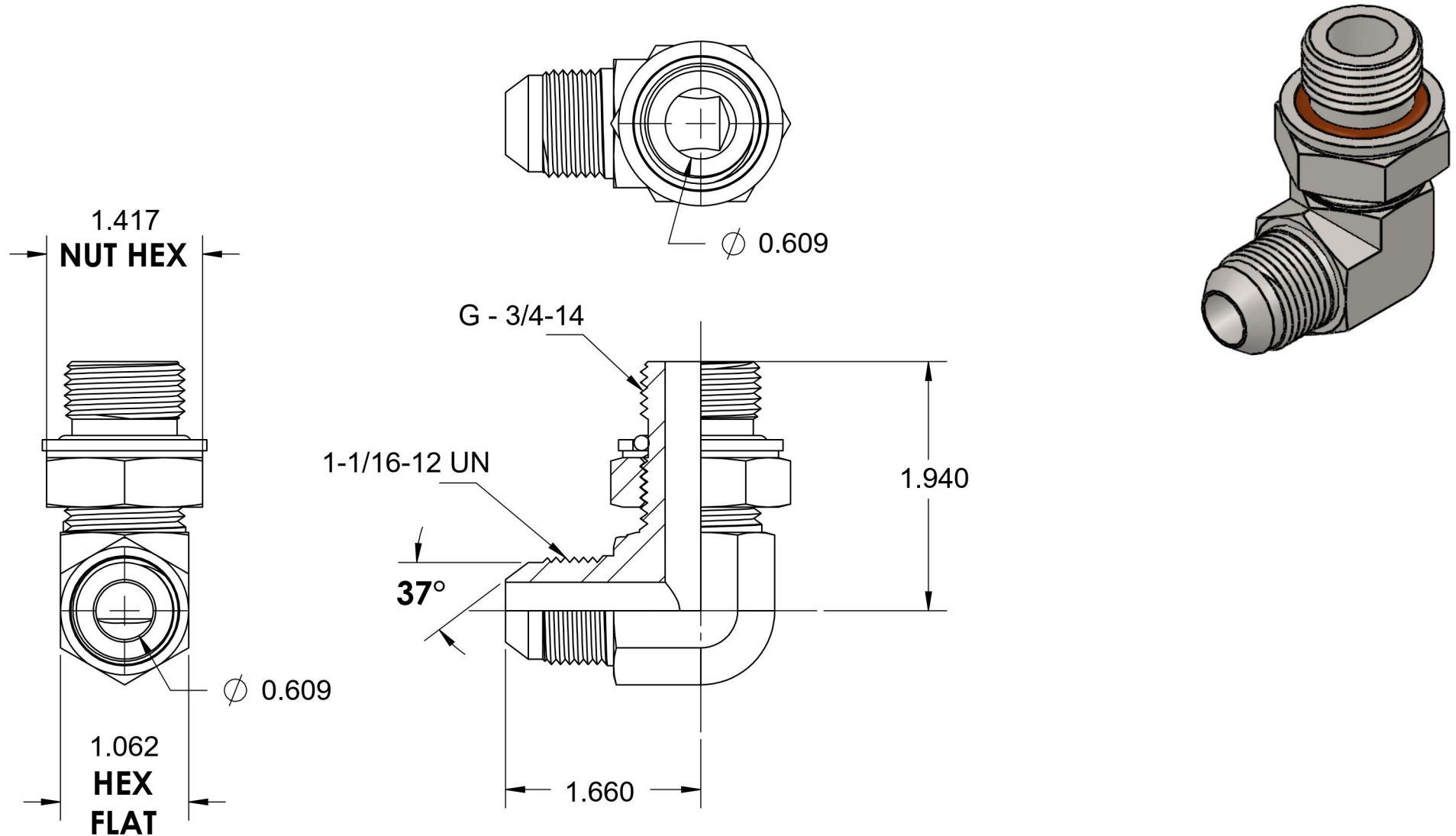

6701 Cochran Road
Solon, Ohio 44139
Phone: (440) 248-1880
Toll Free: 1-888-331-1523

Temperature Rating	Material	Industry Standards	Series
-15°F to 400°F	C1045 Steel	SAE J514, ISO 1179 ASTM B633	7202-NWO-FG-ORR
Pressure Rating	Finish		Series Description
3600 psi	Trivalent Zinc		SAE J514 37° Flare Male BSPP Adjustable (Type H) Port 90° Elbow