

# 5405-12-04

## Steel, SAE J514 Pipe Expander, 3/4" Male NPTF 30° x 1/4" Female NPTF

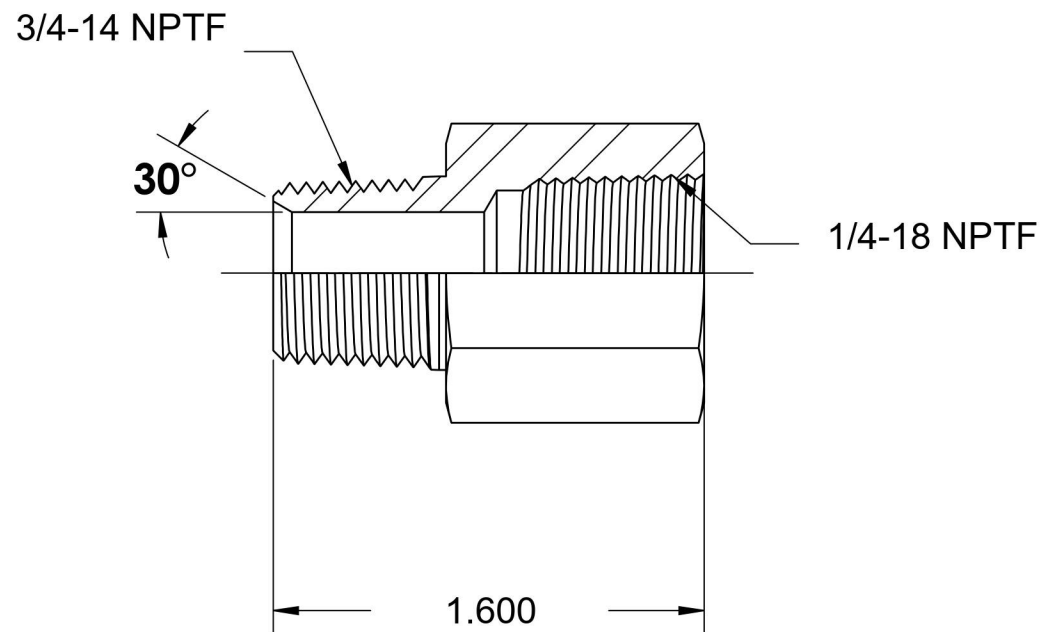
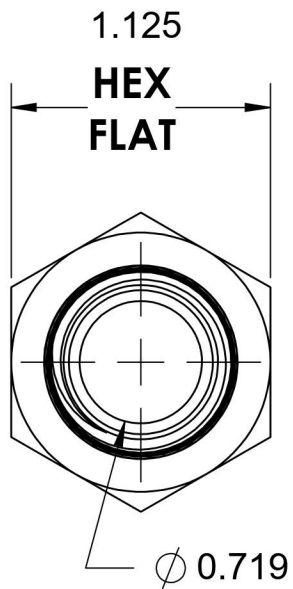
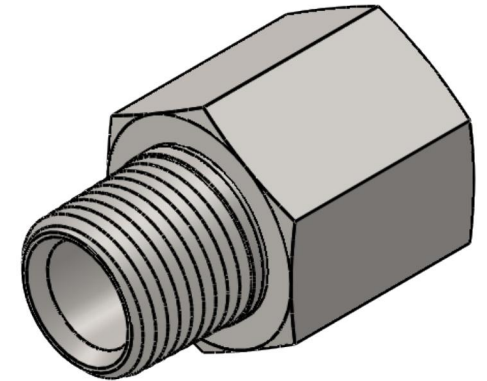

6701 Cochran Road  
Solon, Ohio 44139  
Phone: (440) 248-1880  
Toll Free: 1-888-331-1523

#### Temperature Rating

-65°F to 500°F

#### Pressure Rating

4000 psi

#### Material

C1045/12L14 Steel

#### Finish

Trivalent Zinc

#### Industry Standards

SAE J514 , SAE J476  
ASTM B633

#### Series

5405

#### Series Description

SAE J514 Pipe Expander