

# 7012-06-04

Steel, SAE J514 37° Flare Male BSPP Type (G) Port Connector, 3/8" Male JIC x 1/4-19 Male BSPP ORR

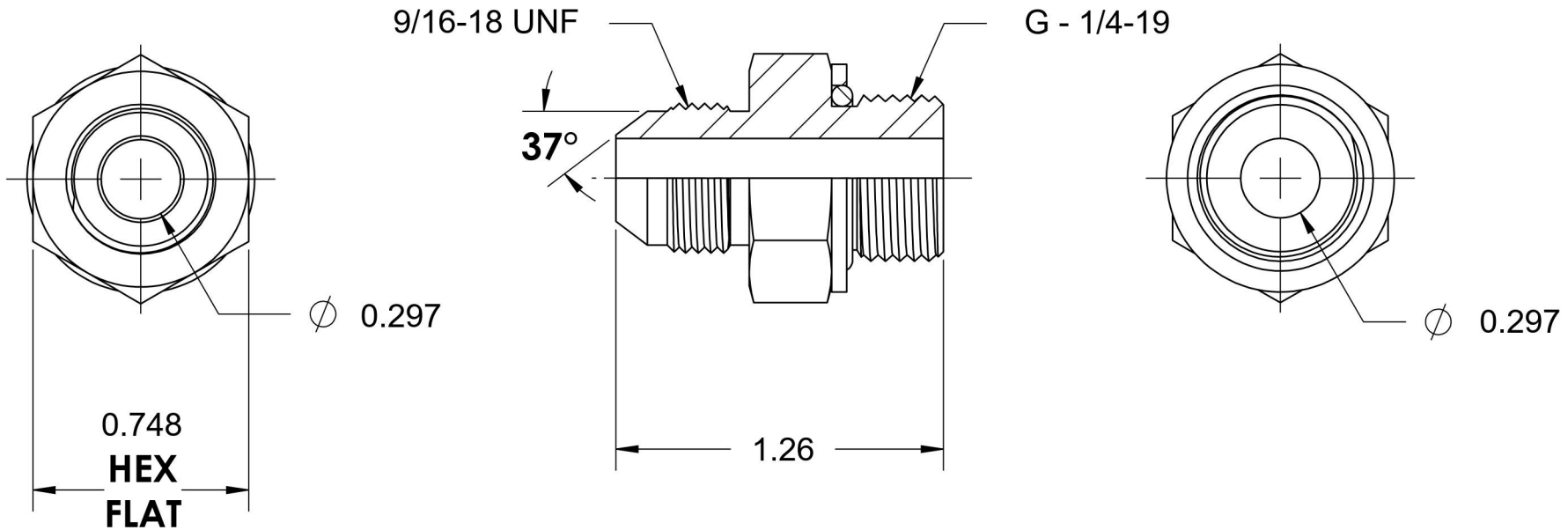

6701 Cochran Road  
Solon, Ohio 44139  
Phone: (440) 248-1880  
Toll Free: 1-888-331-1523

**Temperature Rating**

-40°F to 250°F

**Material**

C1045 / 12L14 Steel

**Industry Standards**

SAE J514, ISO 1179

ASTM B633

**Series**

7012-ORR

**Series Description**

SAE J514 37° Flare Male  
BSPP Type (G) Port Connector

**Pressure Rating**

5000 psi

**Finish**

Trivalent Zinc