

# 7202-08-10-NWO-FG

Steel, SAE J514 37° Flare Male BSPP Adjustable (Type H) Port 90° Elbow, 1/2" Male JIC x 5/8-14 Male BSPP Adjustable ORR

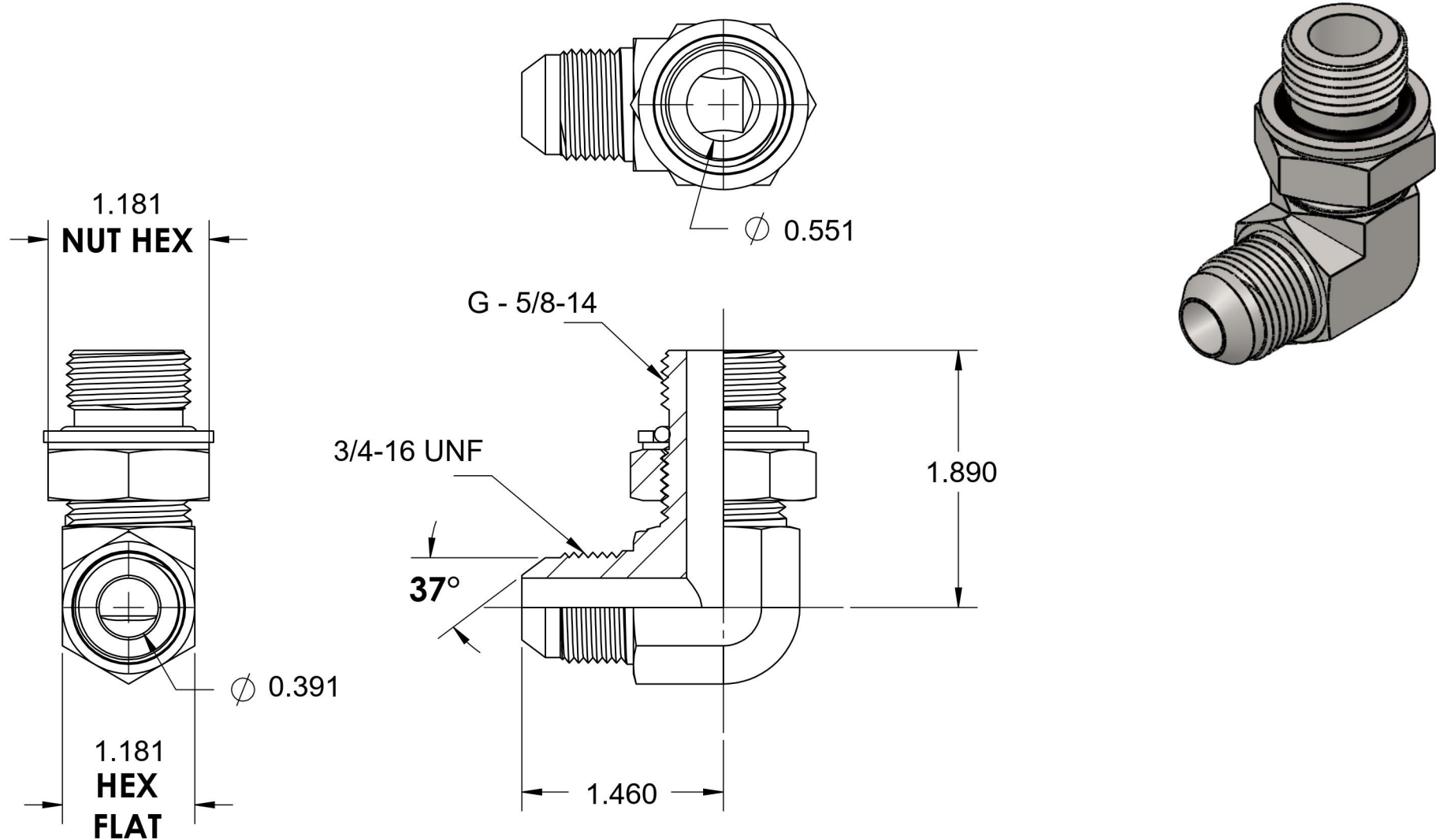

6701 Cochran Road  
Solon, Ohio 44139  
Phone: (440) 248-1880  
Toll Free: 1-888-331-1523

**Temperature Rating**

-40°F to 250°F

**Pressure Rating**

3600 psi

**Material**

C1045 Steel

**Finish**

Trivalent Zinc

**Industry Standards**

SAE J514, ISO 1179  
ASTM B633

**Series**

7202-NWO-FG-ORR

**Series Description**

SAE J514 37° Flare Male BSPP Adjustable (Type H) Port 90° Elbow