

FS6504-04-04

Steel, SAE J1453 O-Ring Face Seal Swivel Adapter, 1/4" Female ORFS Swivel x 1/4" Male JIC

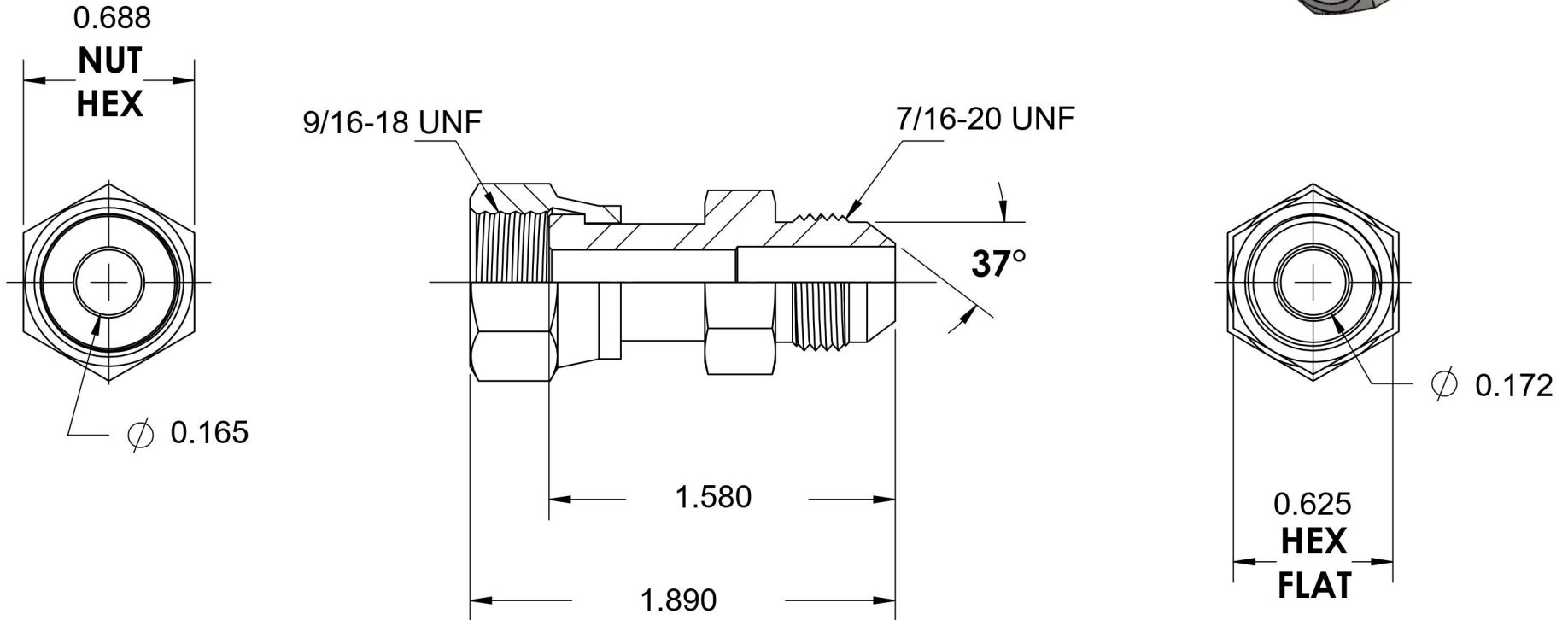
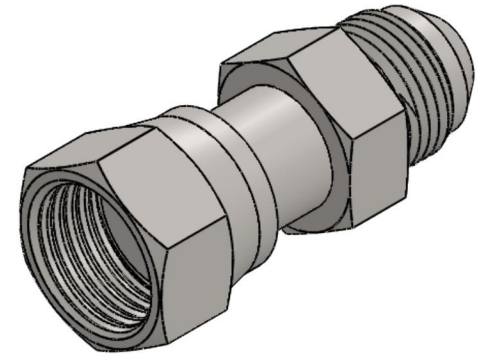

6701 Cochran Road
Solon, Ohio 44139
Phone: (440) 248-1880
Toll Free: 1-888-331-1523

Temperature Rating	Material	Industry Standards	Series
-65°F to 500°F	C1045/12L14 Steel	SAE J1453, SAE J514 ASTM B633	FS6504
Pressure Rating	Finish		Series Description
7500 psi	Trivalent Zinc		SAE J1453 O-Ring Face Seal Swivel Adapter