

5404-12-08

Steel, SAE J514 Pipe Nipple, 3/4" Male NPTF 30° x 1/2" Male NPTF 30°

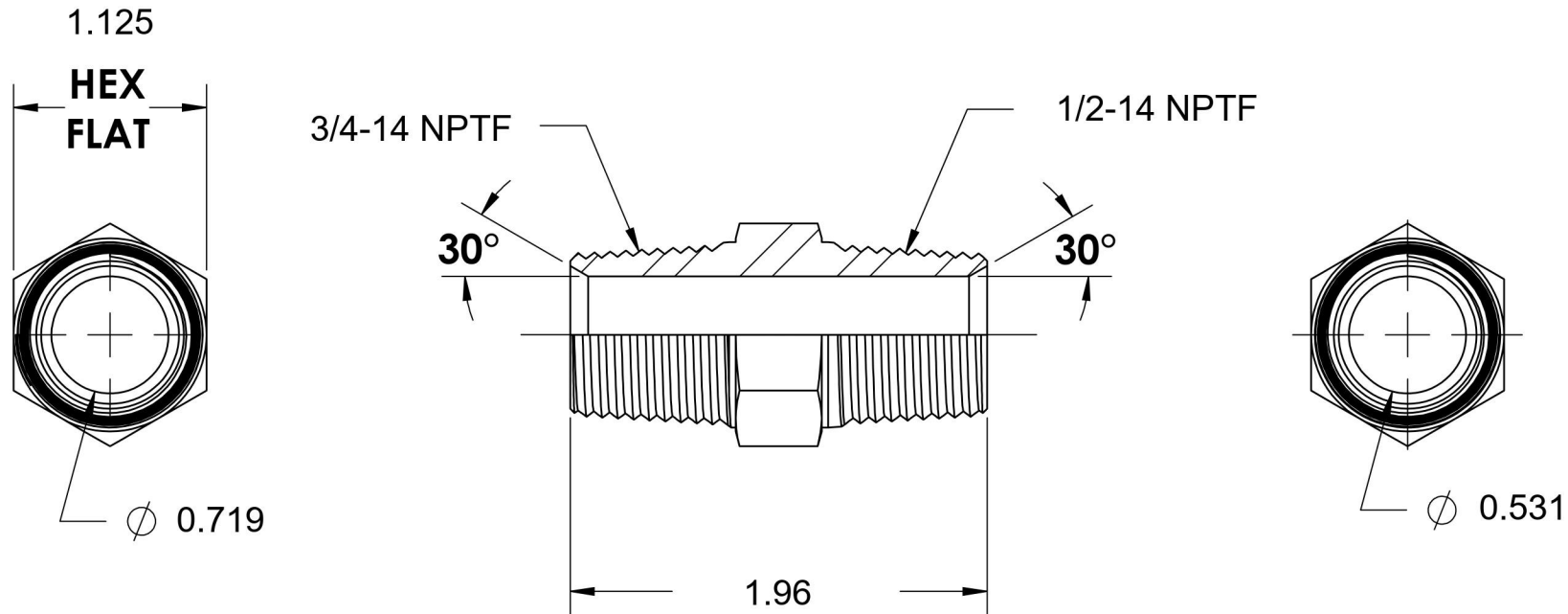

6701 Cochran Road
Solon, Ohio 44139
Phone: (440) 248-1880
Toll Free: 1-888-331-1523

Temperature Rating

-65°F to 500°F

Pressure Rating

5500 psi

Material

C1045/12L14 Steel

Finish

Trivalent Zinc

Industry Standards

SAE J514 , SAE J476

ASTM B633

Series

5404

Series Description

SAE J514 Pipe Nipple