

# 6801-16-20-NWO-FG-VITON

Steel, SAE J514 37° Flare 90° Adjustable Port Elbow, 1" Male JIC x 1-5/8-12 Male Adjustable ORB, FKM Seal

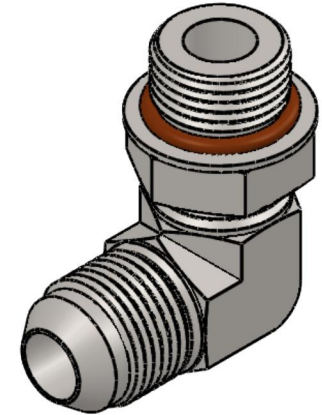
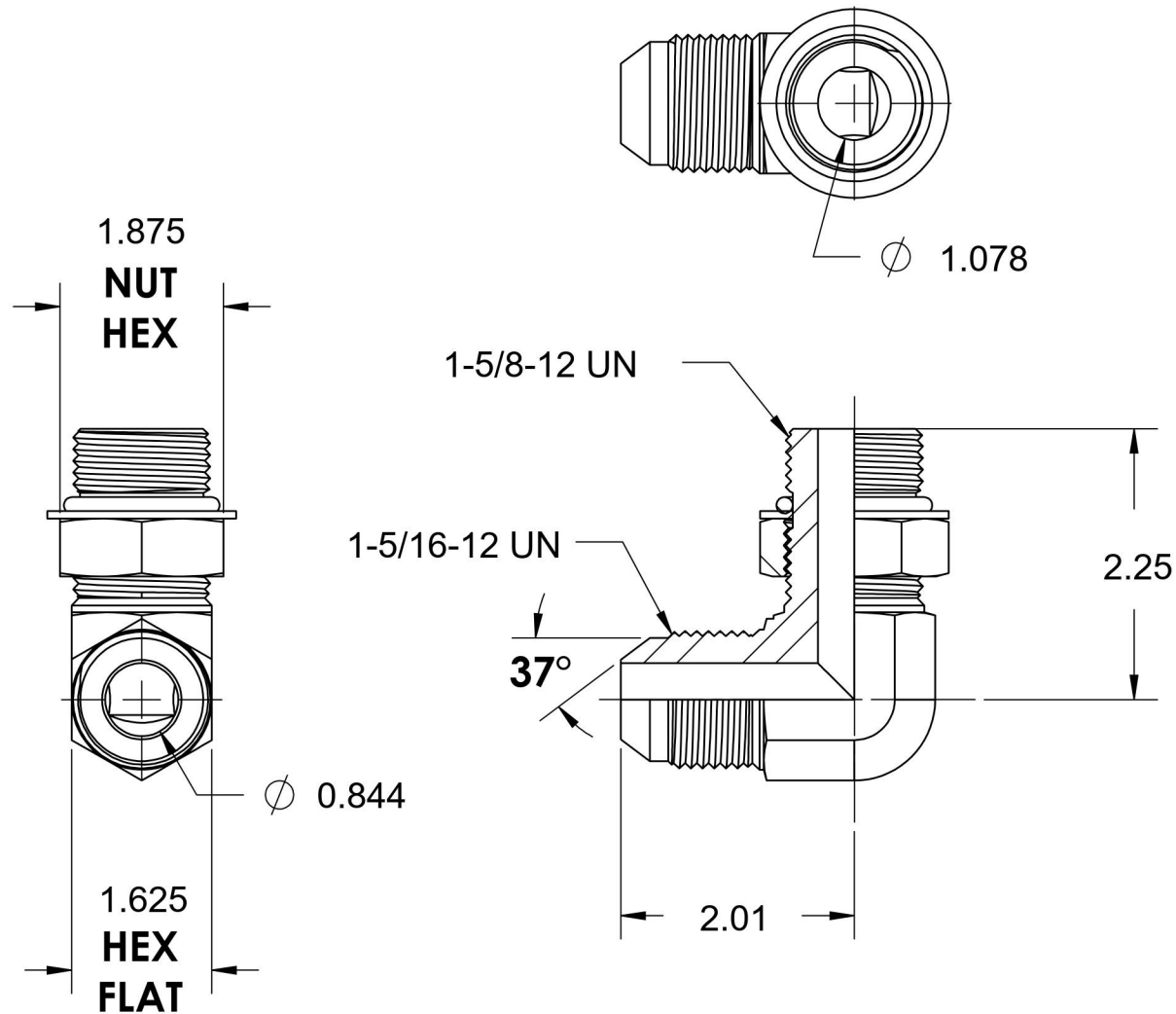

6701 Cochran Road  
Solon, Ohio 44139  
Phone: (440) 248-1880  
Toll Free: 1-888-331-1523

|                           |                 |                                    |   |
|---------------------------|-----------------|------------------------------------|---|
| <b>Temperature Rating</b> | <b>Material</b> | <b>Industry Standards</b>          | <b>Series</b>                                   |
| -15°F / 400°F             | C1045 Steel     | SAE J514, SAE J1926-3<br>ASTM B633 | 6801-NWO-FG-VITON                               |
| <b>Pressure Rating</b>    | <b>Finish</b>   |                                    | <b>Series Description</b>                       |
| 3000 psi                  | Trivalent Zinc  |                                    | SAE J514 37° Flare 90°<br>Adjustable Port Elbow |