

FS6802-08-10-NWO-FG-VITON

Steel, SAE J1453 O-Ring Face Seal 45° Adjustable Port Elbow, 1/2" Male ORFS x 7/8-14 Male Adjustable ORB, FKM Seal

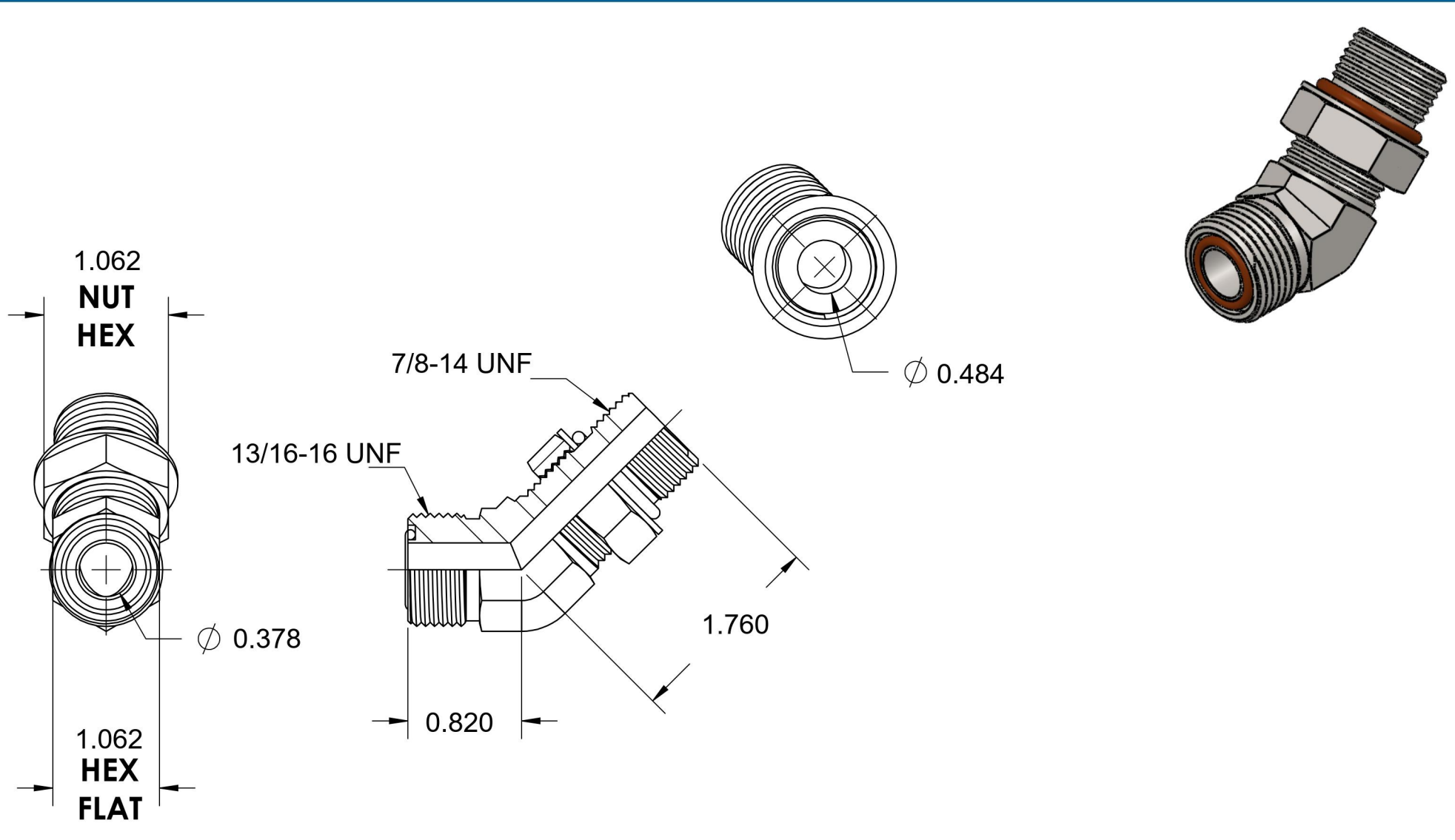

6701 Cochran Road
Solon, Ohio 44139
Phone: (440) 248-1880
Toll Free: 1-888-331-1523

Temperature Rating	Material	Industry Standards	Series
-15°F to 400°F	C1045 Steel	SAE J1453, SAE J1926-2 SAE J515, ASTM B633	FS6802-NWO-FG-VITON
Pressure Rating	Finish		Series Description
6000 psi	Trivalent Zinc		SAE J1453 O-Ring Face Seal 45° Adjustable Port Elbow