

2406-04-04-R.078

04FJ-04MJ Straight, Restricted .078"ID

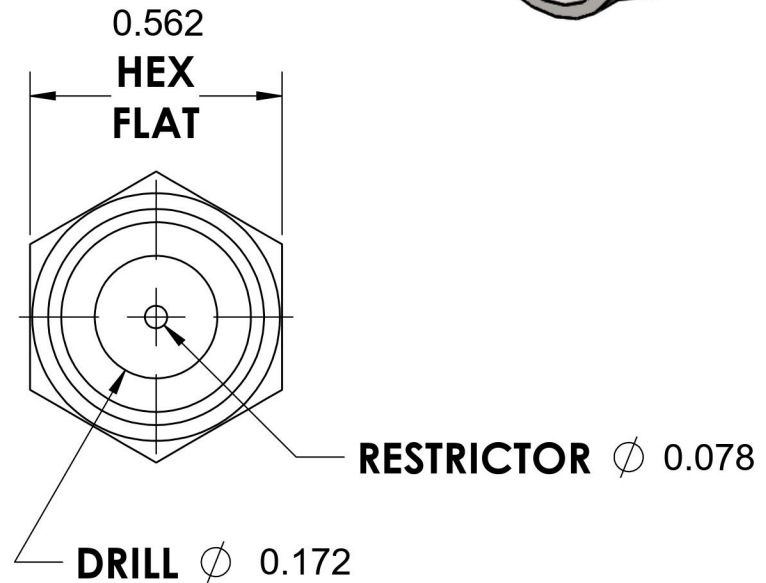
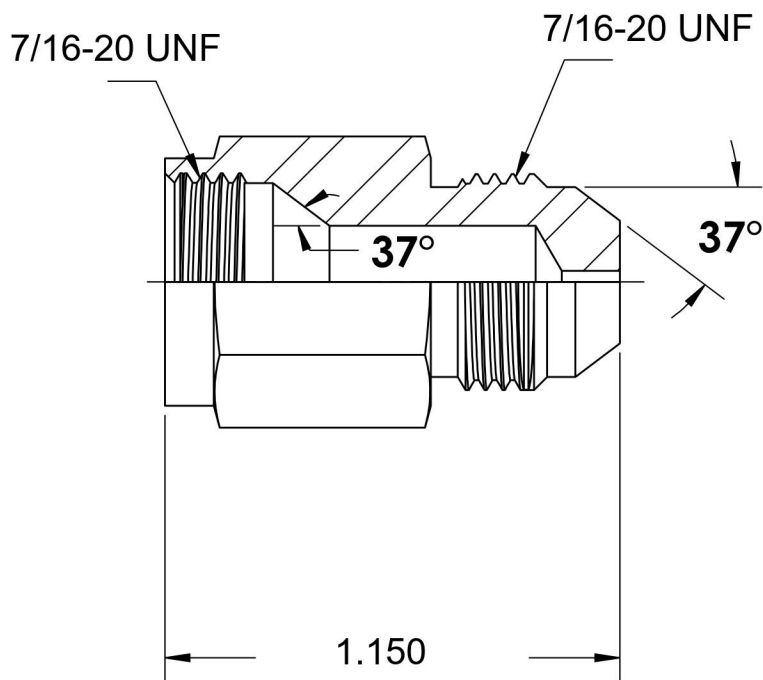
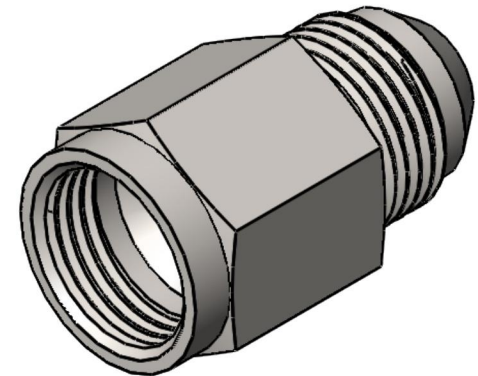

6701 Cochran Road
Solon, Ohio 44139
Phone: (440) 248-1880
Toll Free: 1-888-331-1523

Temperature Rating -65°F to 500°F	Material C1045/12L14 Steel	Industry Standards SAE J514, ASTM B633	Series 2406-RESTRICTED
Pressure Rating Not Available	Finish Trivalent Zinc		Series Description SAE J514 37° Flare Restricted Reducer