

FS6802-12-16-NWO-FG

Steel, SAE J1453 O-Ring Face Seal 45° Adjustable Port Elbow, 3/4" Male ORFS x 1-5/16-12 Male Adjustable ORB

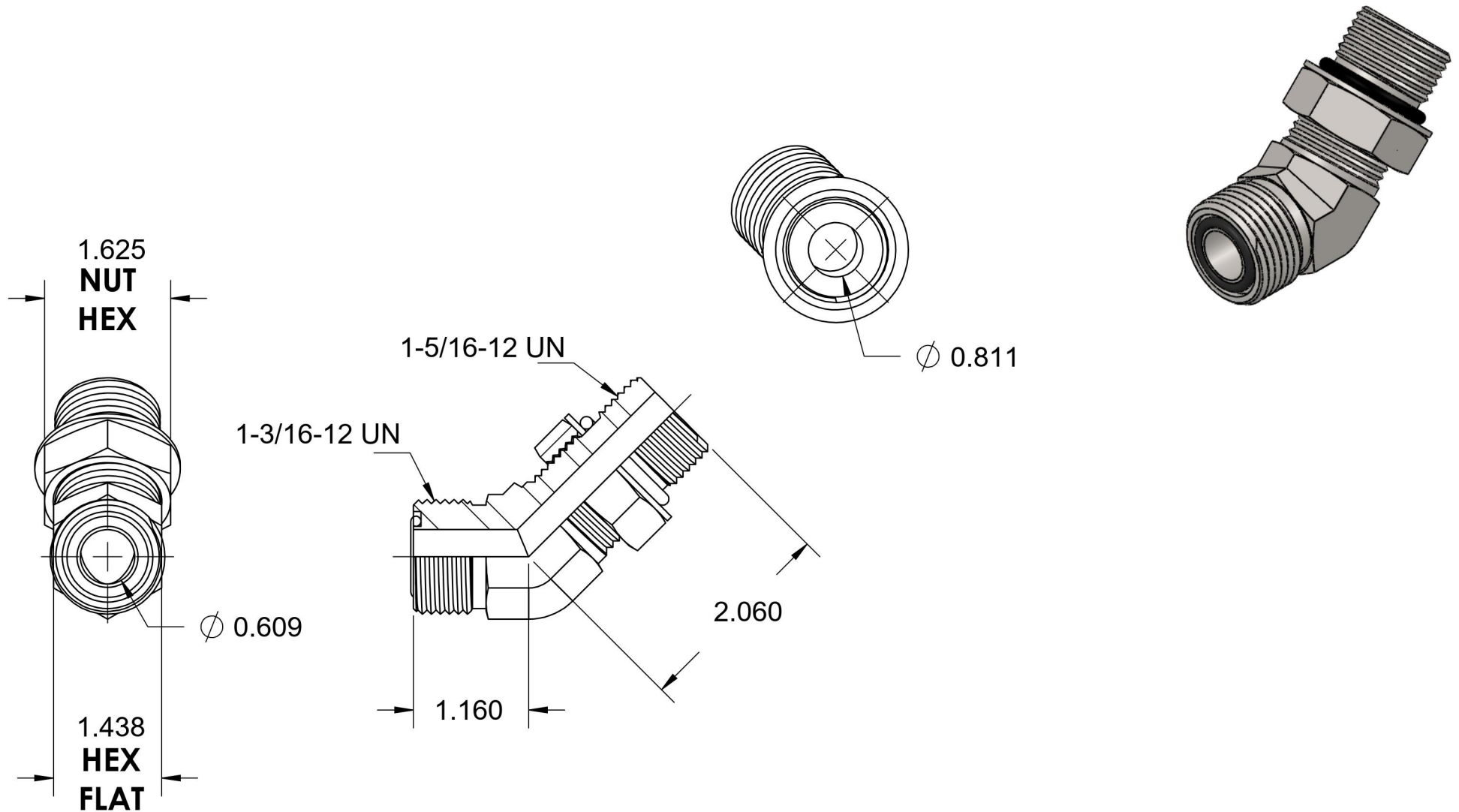

6701 Cochran Road
Solon, Ohio 44139
Phone: (440) 248-1880
Toll Free: 1-888-331-1523

Temperature Rating	Material	Industry Standards	Series
-40°F to 250°F	C1045 Steel	SAE J1453, SAE J1926-2 SAE J515, ASTM B633	FS6802-NWO-FG
Pressure Rating	Finish		Series Description
5500 psi	Trivalent Zinc		SAE J1453 O-Ring Face Seal 45° Adjustable Port Elbow