

C0318-04-SS

Stainless Steel, SAE J514 Flareless Tube Nut, 1/4" Flareless Bite Type Nut

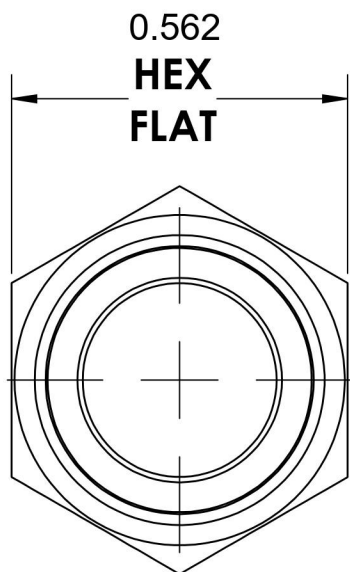

7/16-20 UNF

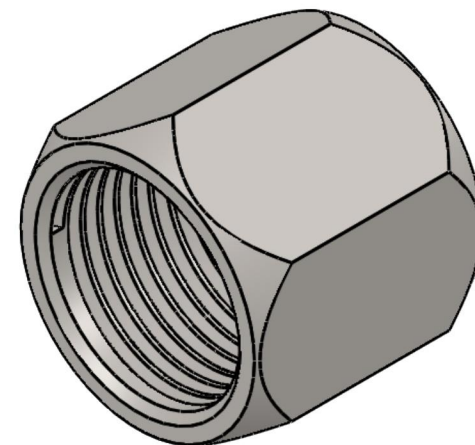
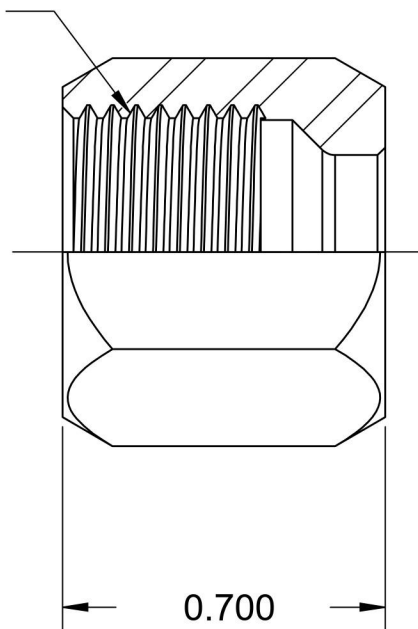

6701 Cochran Road
Solon, Ohio 44139
Phone: (440) 248-1880
Toll Free: 1-888-331-1523

Temperature Rating -425°F to 1200°F	Material 316/316L Stainless	Industry Standards SAE J514	Series C0318
Pressure Rating Not Applicable	Finish Passivation		Series Description SAE J514 Flareless Tube Nut