

1824-16

16 O-Ring Face Flange Plug Code 62

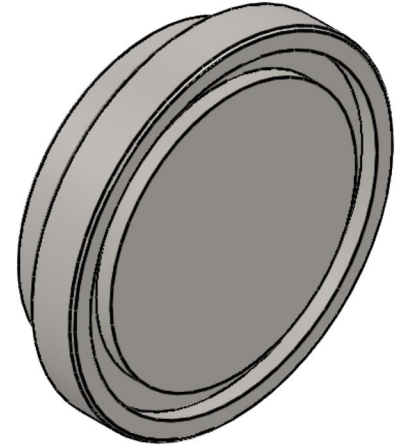
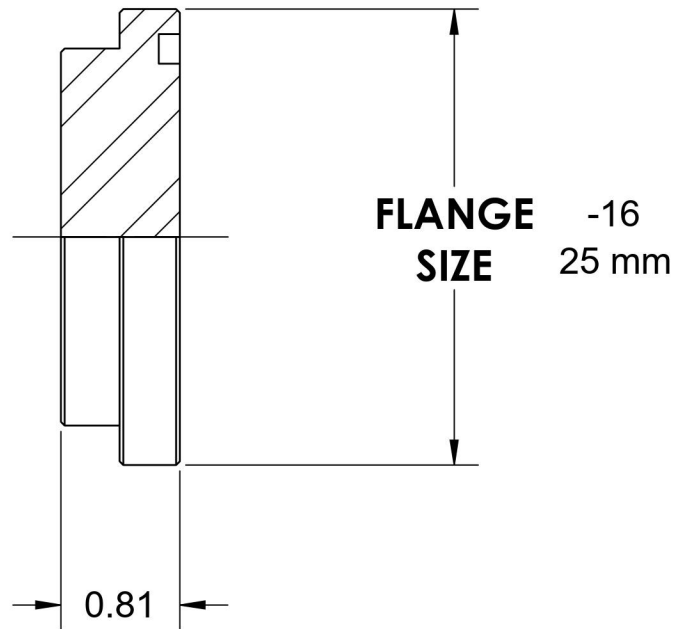
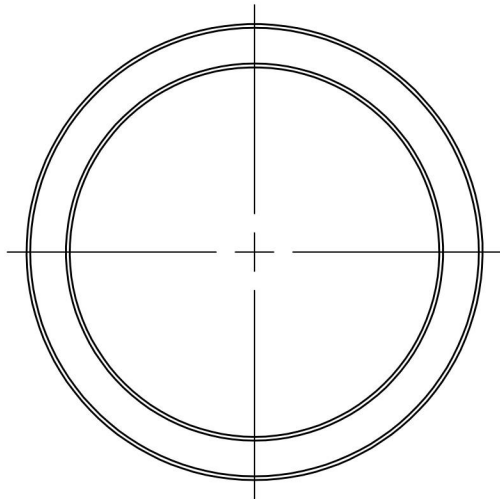

6701 Cochran Road
Solon, Ohio 44139
Phone: (440) 248-1880
Toll Free: 1-888-331-1523

Temperature Rating -65°F to 500°F	Material C1045/12L14 Steel	Industry Standards SAE J518, ASTM B633	Series 1824
Pressure Rating 6000 psi	Finish Trivalent Zinc		Series Description SAE J518 Code 62 Flange Plug