

6803-12-12-08-NWO-FG

Steel, SAE J514 37° Flare Adjustable Port Branch Tee, 3/4" Male JIC x 3/4" Male JIC x 3/4-16 Male Adjustable ORB

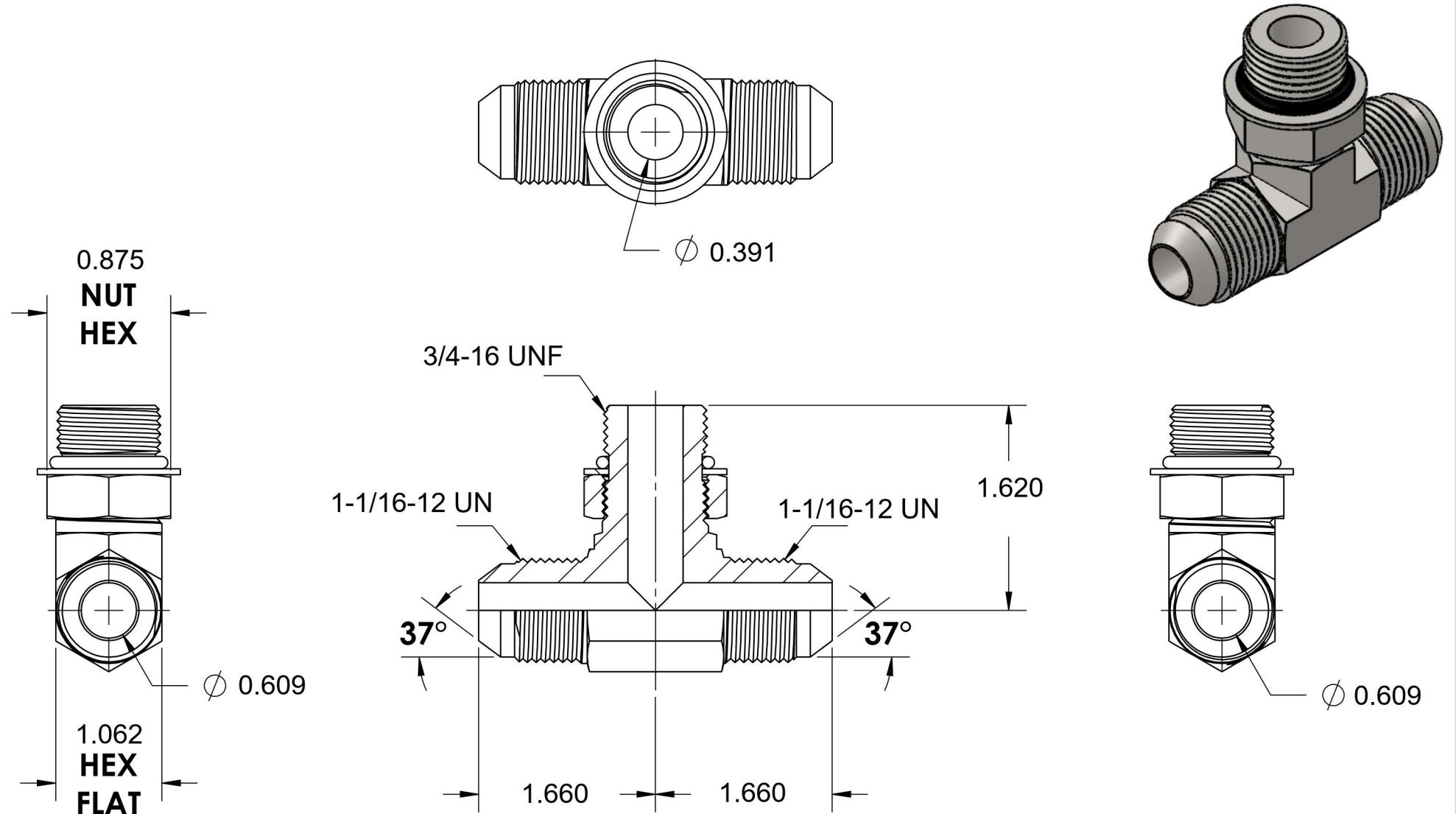

6701 Cochran Road
Solon, Ohio 44139
Phone: (440) 248-1880
Toll Free: 1-888-331-1523

Temperature Rating

-40°F to 250°F

Pressure Rating

5000 psi

Material

C1045 Steel

Finish

Trivalent Zinc

Industry Standards

SAE J514, SAE J1926-3
SAE J515, ASTM B633

Series

6803-NWO-FG

Series Description

SAE J514 37° Flare Adjustable
Port Branch Tee