

FS6400-20-20-O-VITON

Steel, SAE J1453 O-Ring Face Seal Port Connector, 1-1/4" Male ORFS x 1-5/8-12 Male ORB, FKM Seal

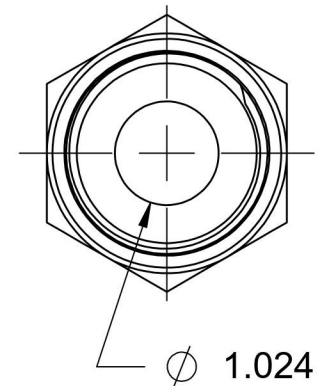
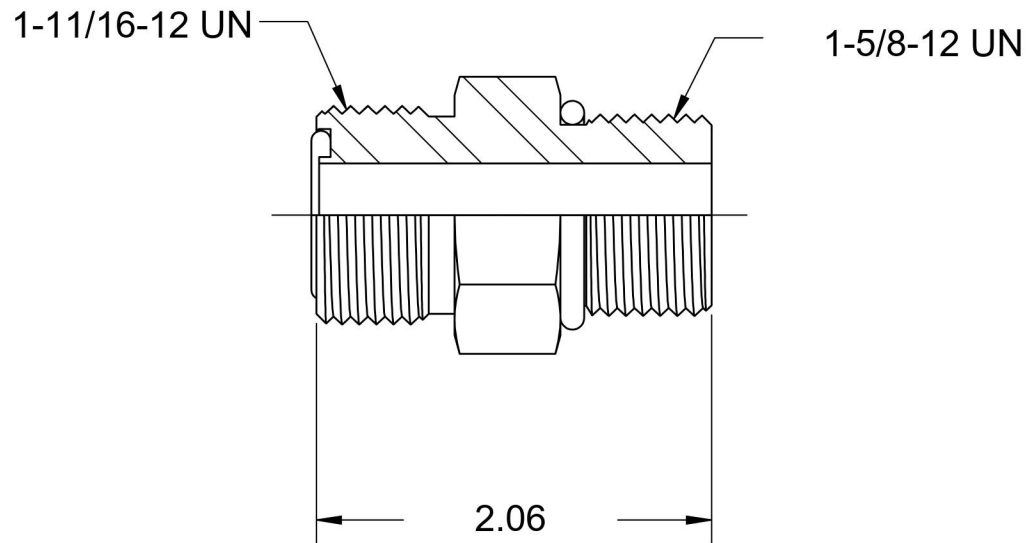
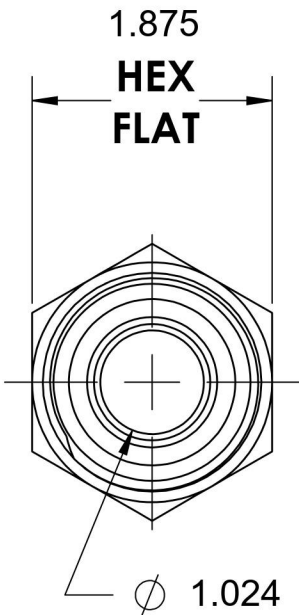

6701 Cochran Road
Solon, Ohio 44139
Phone: (440) 248-1880
Toll Free: 1-888-331-1523

Temperature Rating	Material	Industry Standards SAE J1453, SAE J1926-2 ASTM B633	Series FS6400-O-VITON
-15°F to 400°F	C1045 / 12L14 Steel		
Pressure Rating	Finish		Series Description
6000 psi	Trivalent Zinc		SAE J1453 O-Ring Face Seal Port Connector