

6802-32-32-NWO-FG

Steel, SAE J514 37° Flare 45° Adjustable Port Elbow, 2" Male JIC x 2-1/2-12 Male Adjustable ORB

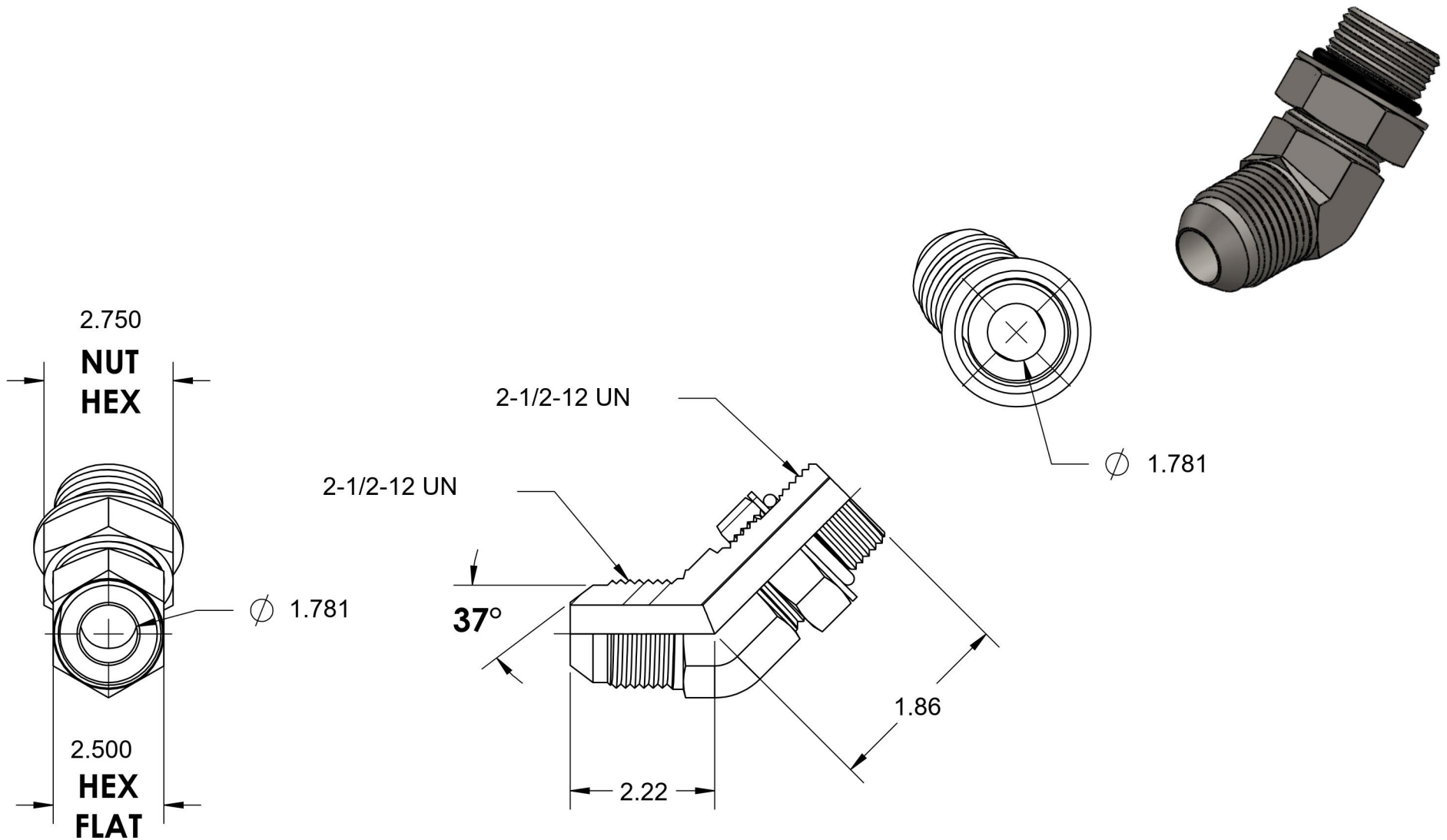

6701 Cochran Road
Solon, Ohio 44139
Phone: (440) 248-1880
Toll Free: 1-888-331-1523

Temperature Rating	Material	Industry Standards	Series
-40°F to 250°F	C1045 Steel	SAE J514, SAE J1926-3	6802-NWO-FG
Pressure Rating	Finish	SAE J515, ASTM B633	Series Description
2000 psi	Trivalent Zinc		SAE J514 37° Flare 45° Adjustable Port Elbow