

1501-24-20-FG

Steel, SAE J514 NPSM Swivel 90° Male Elbow, 1-1/2" Male NPTF 30° x 1-1/4" Female NPSM Swivel

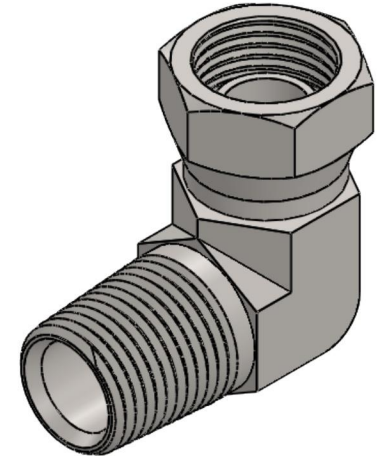
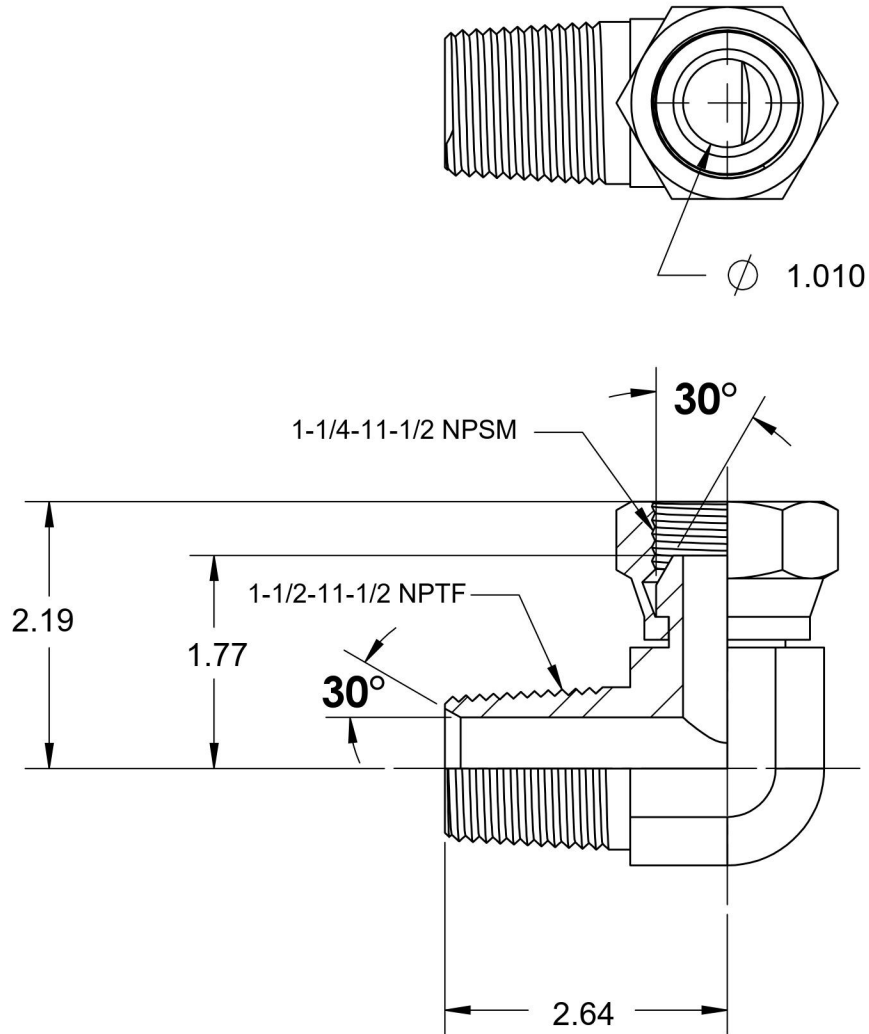
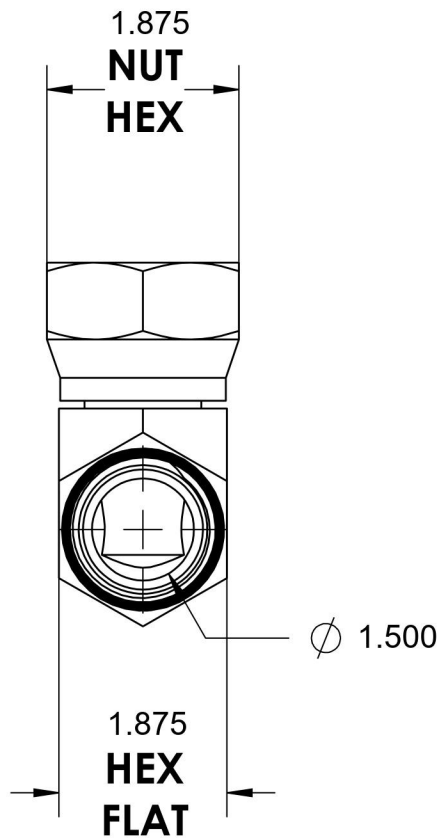

6701 Cochran Road
Solon, Ohio 44139
Phone: (440) 248-1880
Toll Free: 1-888-331-1523

Temperature Rating

-65°F to 500°F

Material

C1045 Steel

Industry Standards

SAE J514, SAE J476
ASTM B633

Series

1501-FG

Pressure Rating

2000 psi

Finish

Trivalent Zinc

Series Description

SAE J514 NPSM Swivel
90° Male Elbow