

# 2501-L-24-24-FG

Steel, SAE J514 37° Flare 90° Long Male Elbow, 1-1/2" Male JIC x 1-1/2" Male NPTF 30°

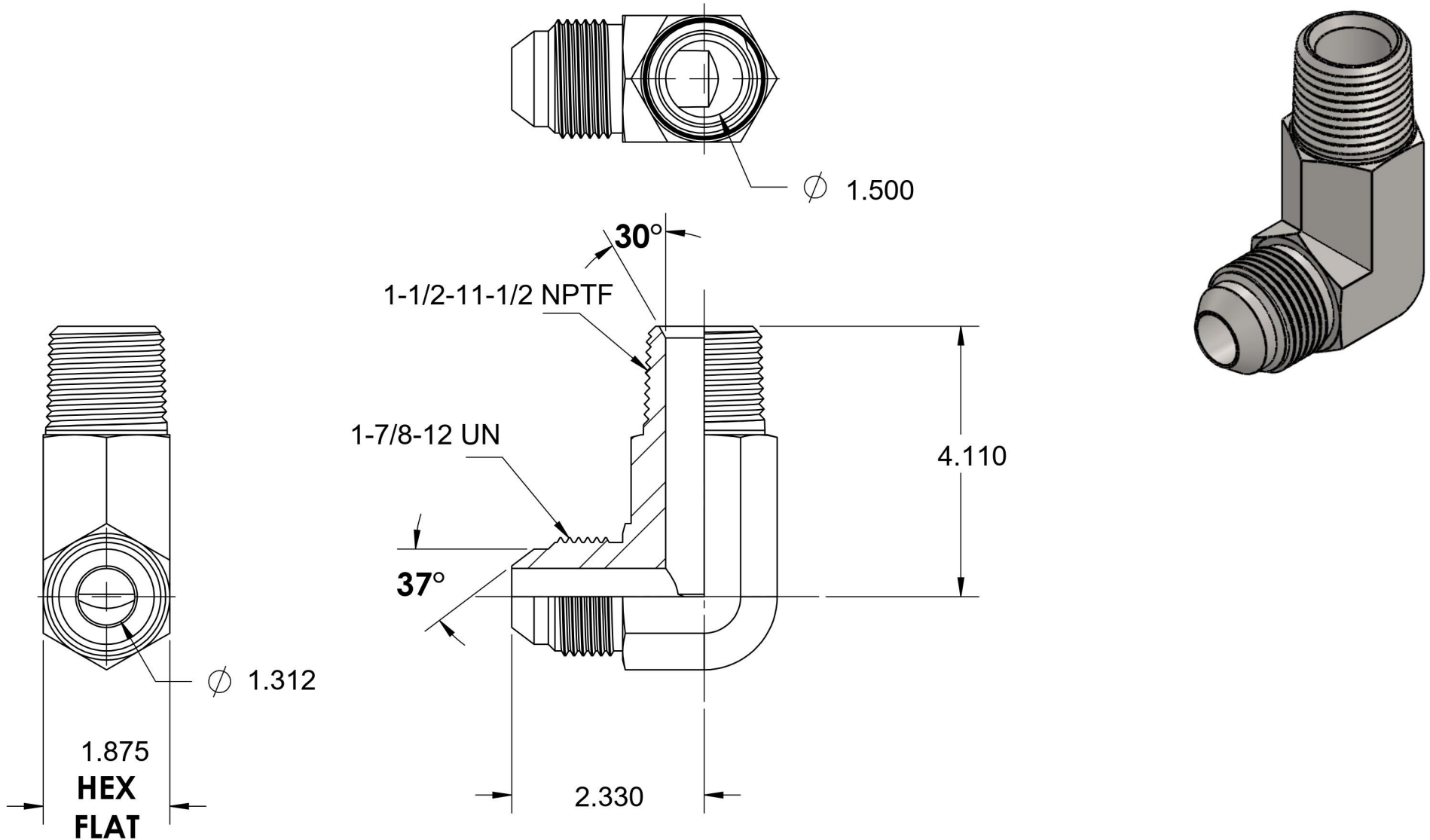

6701 Cochran Road  
Solon, Ohio 44139  
Phone: (440) 248-1880  
Toll Free: 1-888-331-1523

<b>Temperature Rating</b>	<b>Material</b>	<b>Industry Standards</b>	<b>Series</b>
-65°F to 500°F	C1045 Steel	SAE J514 , SAE J476 ASTM B633	2501-L-FG
<b>Pressure Rating</b>	<b>Finish</b>		<b>Series Description</b>
2500psi	Trivalent Zinc		SAE J514 37° Flare 90° Long Male Elbow