

7005-12-16-BS

Steel, SAE J514 37° Flare Metric Type (D) Bonded Seal Port/Line Connector, 3/4" Male JIC x M16X1.5 Male Metric 60° Line/Port

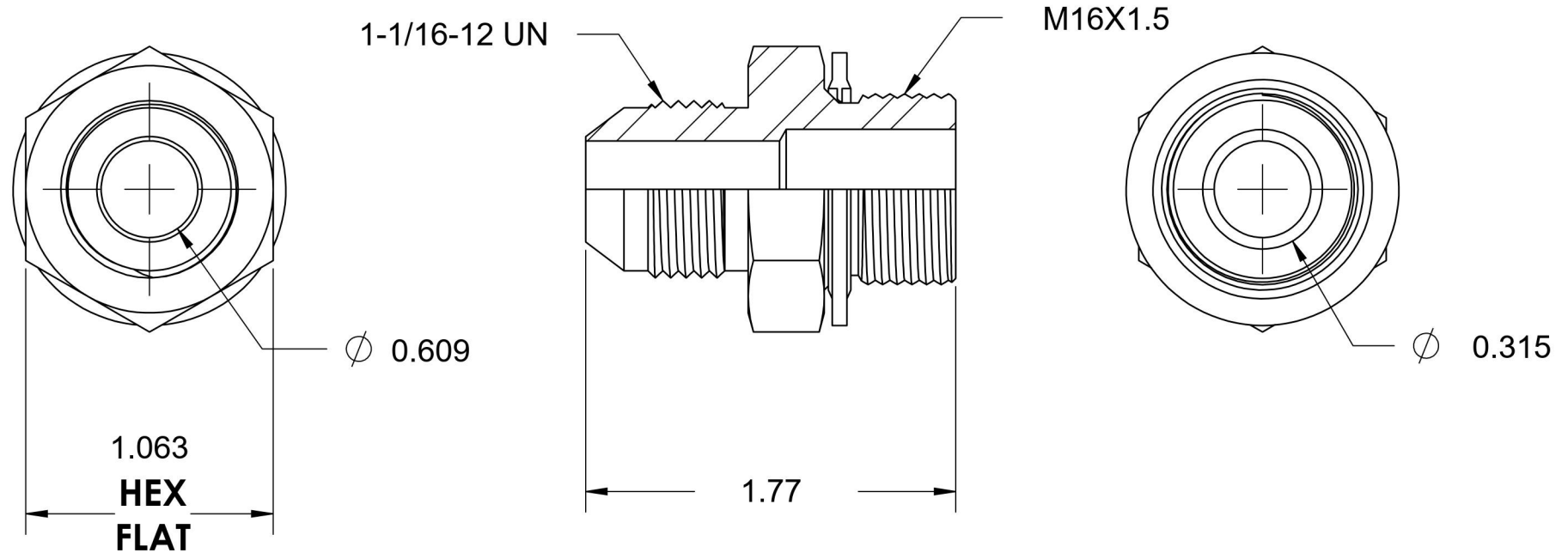

6701 Cochran Road
Solon, Ohio 44139
Phone: (440) 248-1880
Toll Free: 1-888-331-1523

Temperature Rating

-40°F to 250°F

Pressure Rating

5000 psi

Material

C1045/12L14 Steel

Finish

Trivalent Zinc

Industry Standards

SAE J514, ISO 9974

ASTM B633

Series

7005-BS

Series Description

SAE J514 37° Flare Metric Type (D)
Bonded Seal Port/Line Connector