

6501-04-05-SS

Stainless Steel, SAE J514 37° Flare Swivel 90° Male Elbow, 1/4" Male NPTF 30° x 5/16" Female JIC Swivel

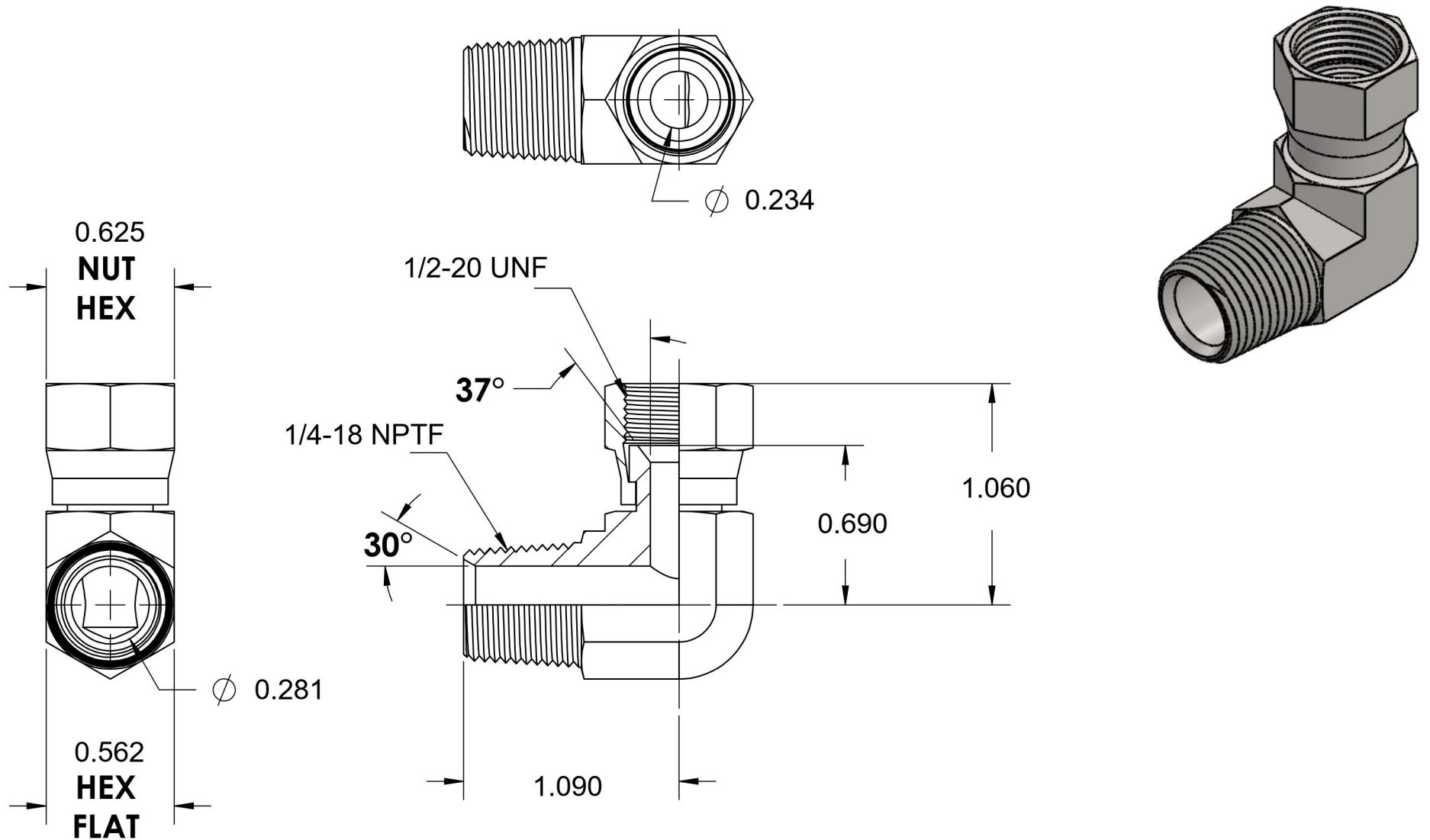

6701 Cochran Road
Solon, Ohio 44139
Phone: (440) 248-1880
Toll Free: 1-888-331-1523

Temperature Rating	Material	Industry Standards	Series
-425°F to 1200°F	316/316L Stainless Steel	SAE J514, SAE J476	6501-SS
Pressure Rating	Finish		Series Description
6000 psi	Passivated		SAE J514 37° Flare Swivel 90° Male Elbow