

6900-10-12-O

Steel, SAE J514 NPSM Swivel Port Connector, 7/8-14 Male ORB x 3/4" Female NPSM Swivel

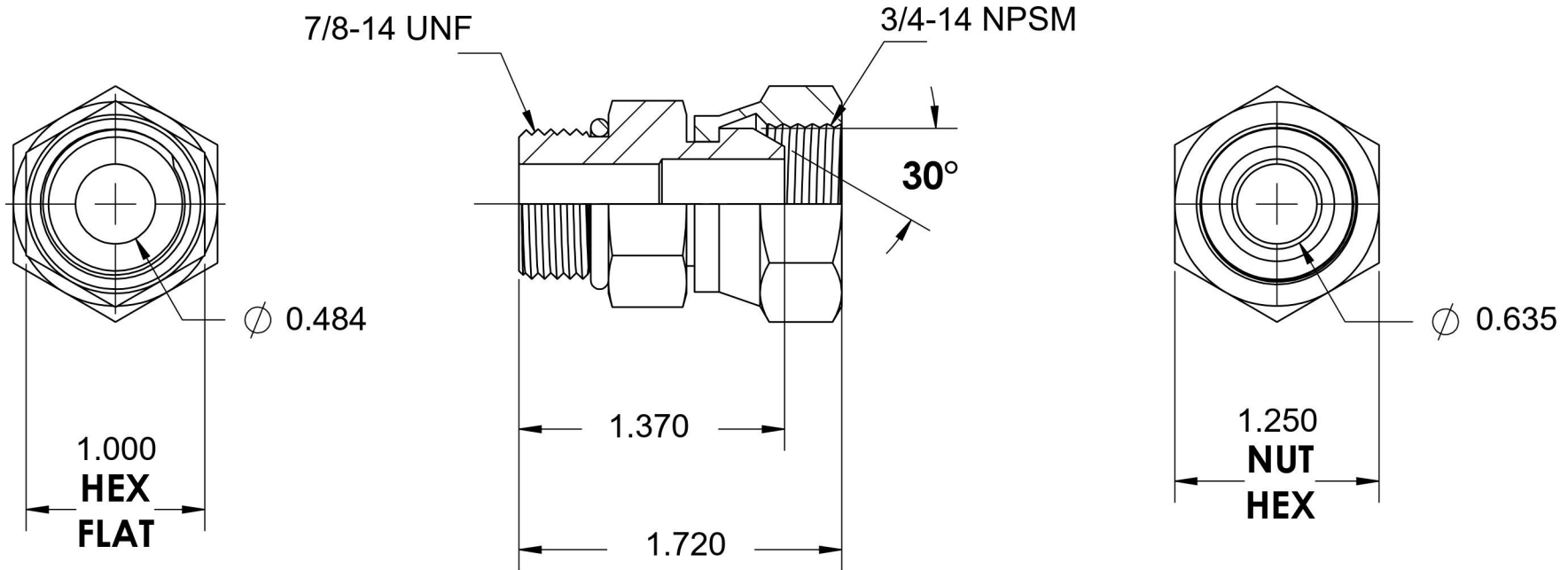
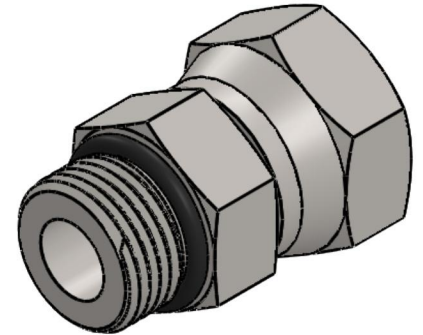

6701 Cochran Road
Solon, Ohio 44139
Phone: (440) 248-1880
Toll Free: 1-888-331-1523

Temperature Rating	Material	Industry Standards	Series
-40°F to 250°F	C1045/12L14 Steel	SAE J514, SAE J476 SAE J1926-3, SAE J515	6900-O
Pressure Rating	Finish	ASTM B633	Series Description
4000 psi	Trivalent Zinc		SAE J514 NPSM Swivel Port Connector