

C2501-02-02-FG

Steel, SAE J514 Flareless Tube 90° Male Elbow, 1/8" Flareless Bite Type x 1/8" Male NPTF 30°

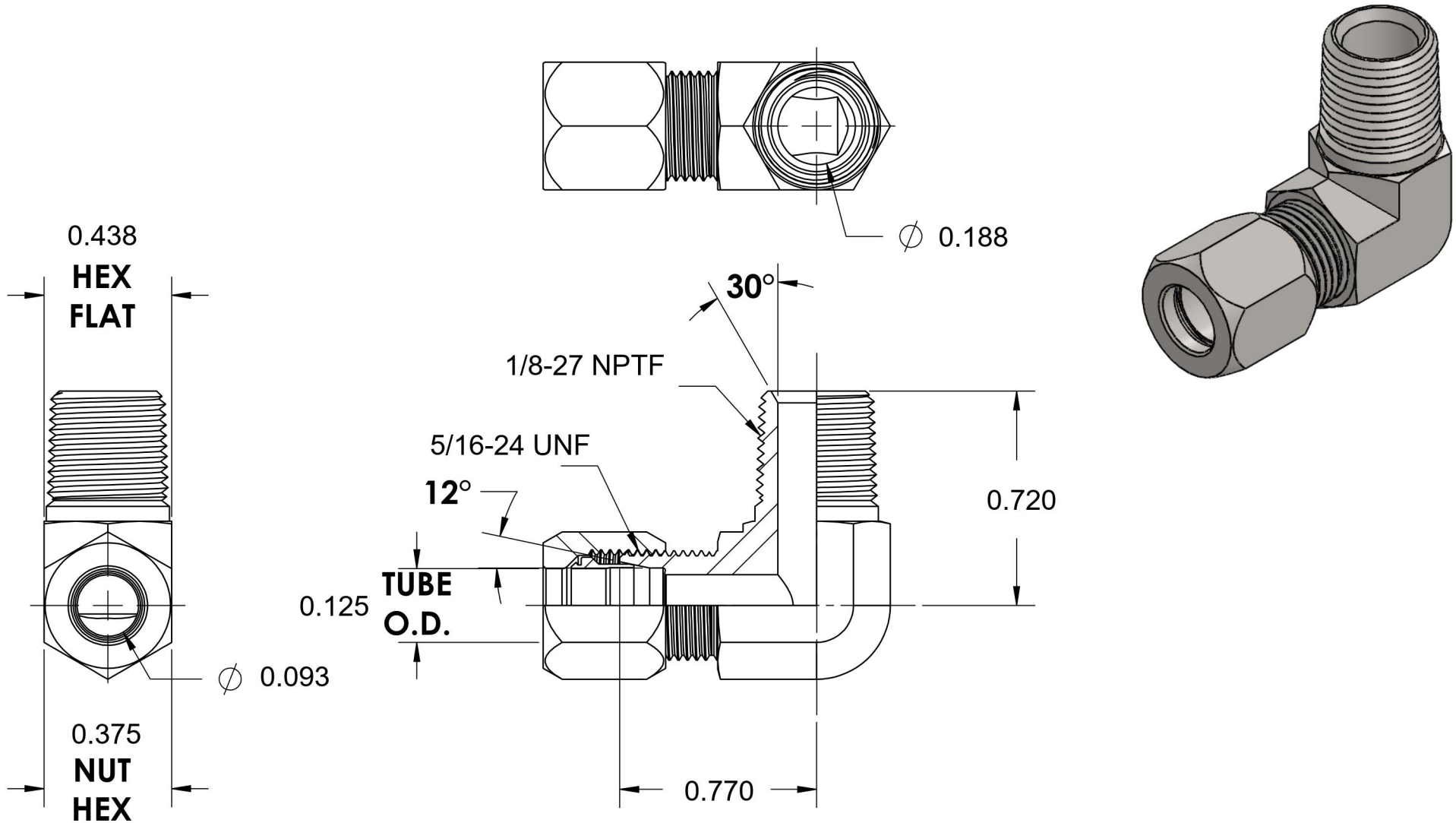

6701 Cochran Road
Solon, Ohio 44139
Phone: (440) 248-1880
Toll Free: 1-888-331-1523

Temperature Rating	Material	Industry Standards	Series
-65°F to 500°F	C1045 Steel	SAE J514, SAE J476 ASTM B633	C2501-FG
Pressure Rating	Finish		Series Description
5000 psi	Trivalent Zinc		SAE J514 Flareless Tube 90° Male Elbow