

C6400-06-04-O-SS

Stainless Steel, SAE J514 Flareless Tube Port Connector, 3/8" Flareless Bite Type x 7/16-20 Male ORB

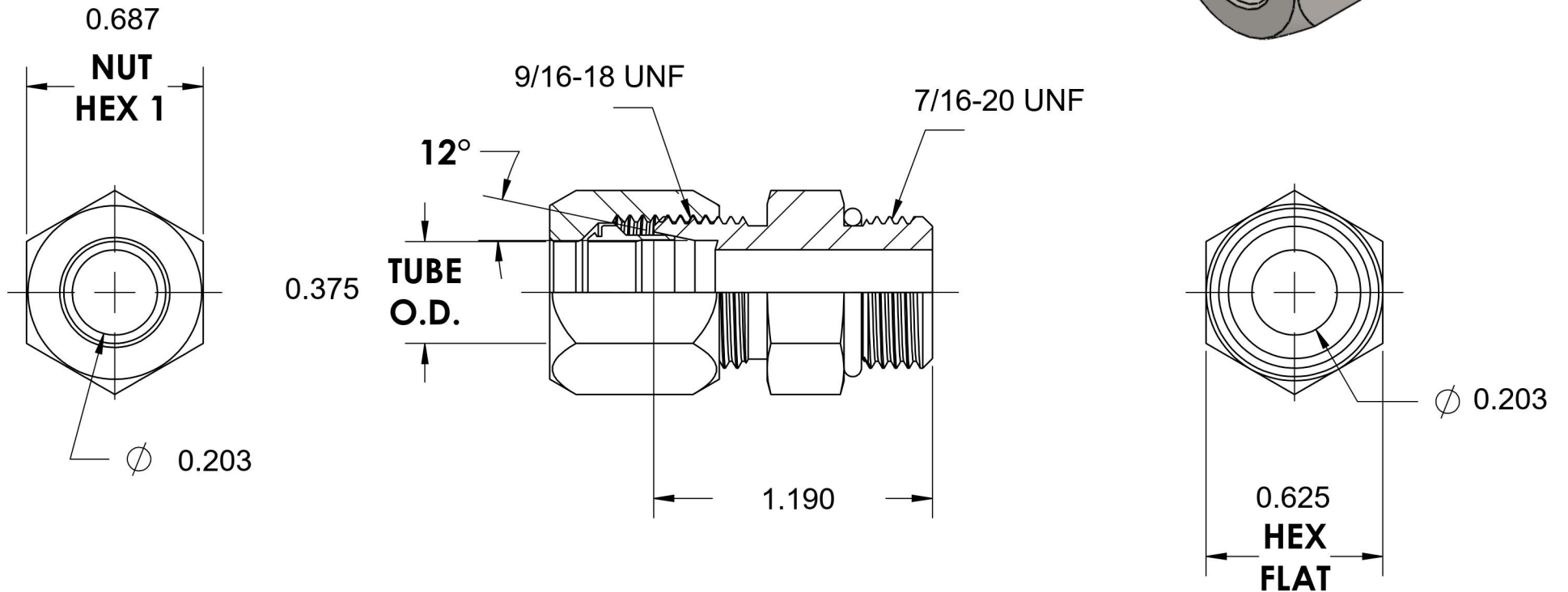
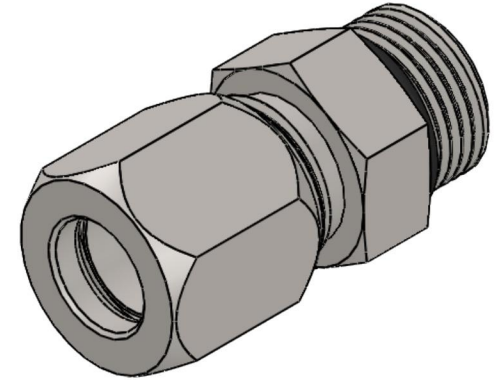

6701 Cochran Road
Solon, Ohio 44139
Phone: (440) 248-1880
Toll Free: 1-888-331-1523

Temperature Rating	Material	Industry Standards	Series
-40°F to 250°F	316/316L Stainless	SAE J514, SAE J1926	C6400-O
Pressure Rating	Finish		Series Description
6000psi	Passivation		SAE J514 Flareless Tube Port Connector